



TSM2301

-20V P-Channel Enhancement Mode MOSFET

SOT-23



Pin assignment:

1. Gate
2. Source
3. Drain

$V_{DS} = -20V$

$R_{DS(on)}, V_{GS} @ -4.5V, I_{DS} @ -2.8A = 130m\Omega$

$R_{DS(on)}, V_{GS} @ -2.5V, I_{DS} @ -2.0A = 190m\Omega$

Features

- ◇ Advanced trench process technology
- ◇ High density cell design for ultra low on-resistance
- ◇ Excellent thermal and electrical capabilities
- ◇ Compact and low profile SOT-23 package

Block Diagram

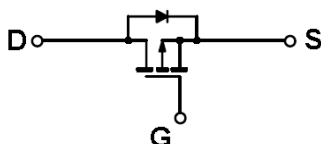

Ordering Information

Part No.	Packing	Package
TSM2301CX	Tape & Reel	SOT-23

Absolute Maximum Rating (Ta = 25 °C unless otherwise noted)

Parameter	Symbol	Limit	Unit
Drain-Source Voltage	V_{DS}	-20V	V
Gate-Source Voltage	V_{GS}	±8	V
Continuous Drain Current	I_D	-2.3	A
Pulsed Drain Current	I_{DM}	-10	A
Maximum Power Dissipation	P_D	Ta = 25 °C	1.25
		Ta = 75 °C	0.8
Operating Junction Temperature	T_J	+150	°C
Operating Junction and Storage Temperature Range	T_J, T_{STG}	- 55 to +150	°C

Thermal Performance

Parameter	Symbol	Limit	Unit
Lead Temperature (1/8" from case)	T_L	5	S
Junction to Ambient Thermal Resistance (PCB mounted)	$R_{\theta ja}$	100	°C/W

Note: Surface mounted on FR4 board t<=5sec.

Electrical Characteristics						
Ta = 25 °C, unless otherwise noted						
Parameter	Conditions	Symbol	Min	Typ	Max	Unit
Static						
Drain-Source Breakdown Voltage	V _{GS} = 0V, I _D = - 250uA	BV _{DSS}	-20	--	--	V
Drain-Source On-State Resistance	V _{GS} = -4.5V, I _D = -2.8A	R _{DS(ON)}	--	95	130	mΩ
Drain-Source On-State Resistance	V _{GS} = -2.5V, I _D = -2.0A	R _{DS(ON)}	--	122	190	
Gate Threshold Voltage	V _{DS} = V _{GS} , I _D = - 250uA	V _{GS(TH)}	-0.45	--	--	V
Zero Gate Voltage Drain Current	V _{DS} = -16V, V _{GS} = 0V	I _{DSS}	--	--	-1.0	uA
Gate Body Leakage	V _{GS} = ±8V, V _{DS} = 0V	I _{GSS}	--	--	±100	nA
On-State Drain Current	V _{DS} ≥ -10V, V _{GS} = -5V	I _{D(ON)}	-6	--	--	A
Forward Transconductance	V _{DS} = - 5V, I _D = - 4A	g _{fs}	--	6.5	--	S
Dynamic						
Total Gate Charge	V _{DS} = -6V, I _D = -2.8A, V _{GS} = -4.5V	Q _g	--	5.4	10	nC
Gate-Source Charge		Q _{gs}	--	0.8	--	
Gate-Drain Charge		Q _{gd}	--	1.1	--	
Turn-On Delay Time	V _{DD} = -6V, R _L = 6Ω, I _D = -1A, V _{GEN} = -4.5V, R _G = 6Ω	t _{d(on)}	--	5	25	nS
Turn-On Rise Time		t _r	--	19	60	
Turn-Off Delay Time		t _{d(off)}	--	95	110	
Turn-Off Fall Time		t _f	--	65	80	
Input Capacitance	V _{DS} = -6V, V _{GS} = 0V, f = 1.0MHz	C _{iss}	--	447	--	pF
Output Capacitance		C _{oss}	--	127	--	
Reverse Transfer Capacitance		C _{rss}	--	80	--	
Source-Drain Diode						
Max. Diode Forward Current		I _S	--	--	-2.4	A
Diode Forward Voltage	I _S = - 1.6A, V _{GS} = 0V	V _{SD}	--	-0.8	-1.2	V

Note : pulse test: pulse width ≤300uS, duty cycle ≤2%

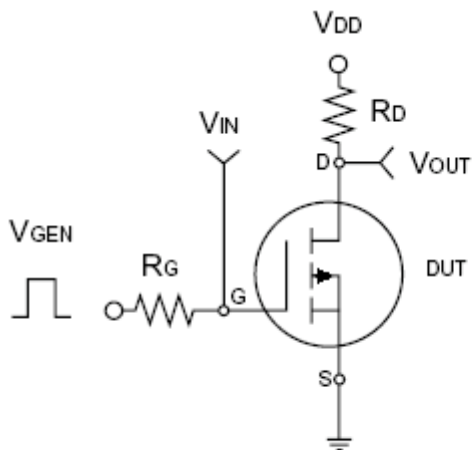

Switching Test Circuit

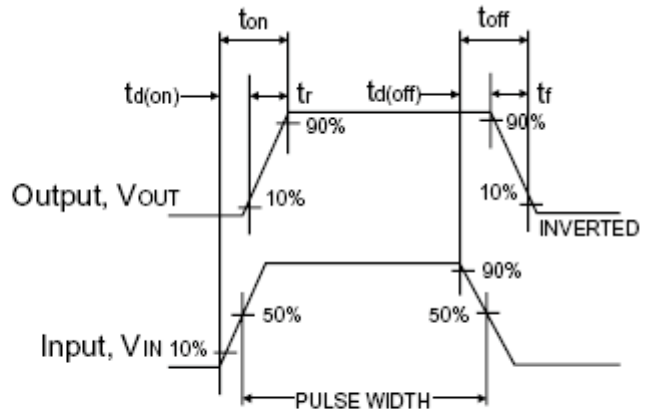

Switchin Waveforms



Typical Characteristics Curve ($T_a = 25^\circ\text{C}$ unless otherwise noted)

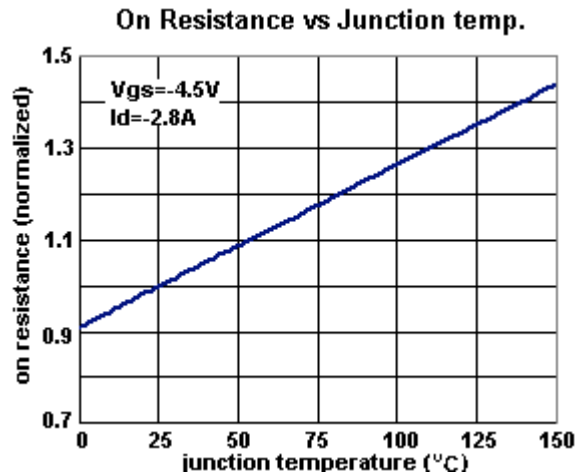
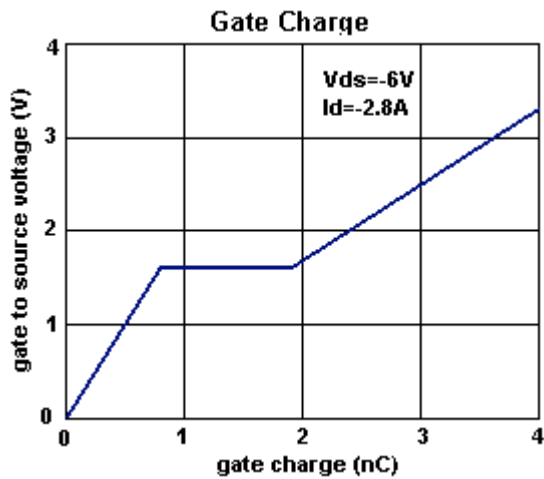
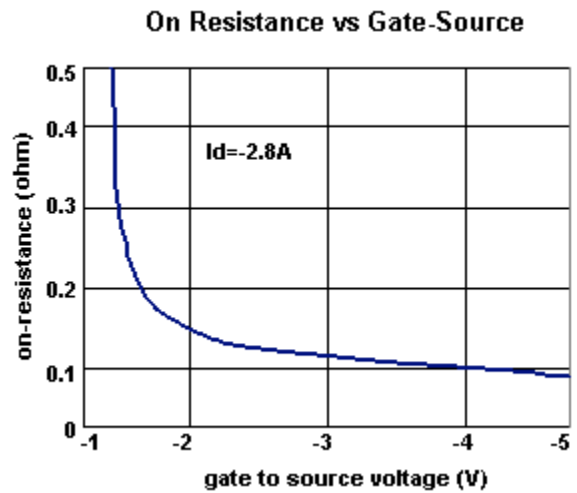
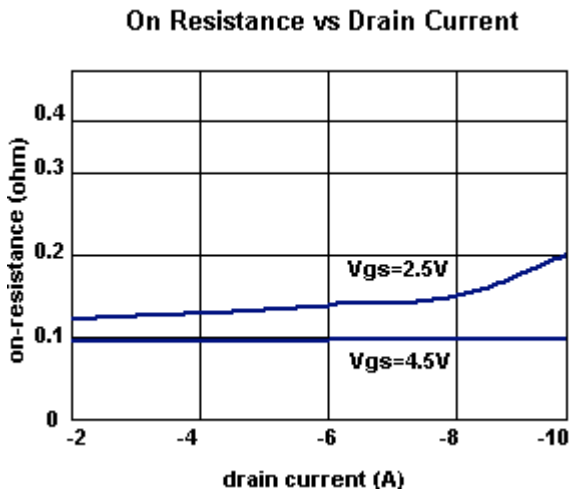
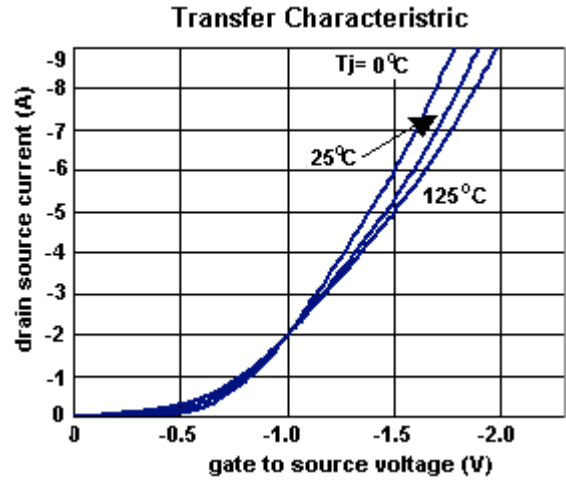
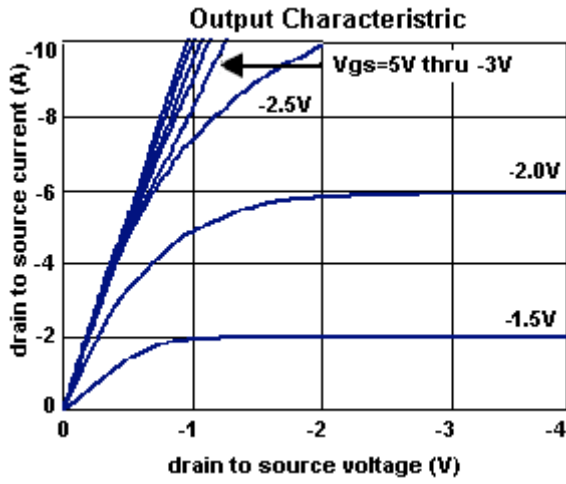



Typical Characteristics Curve (Ta = 25 °C unless otherwise noted)

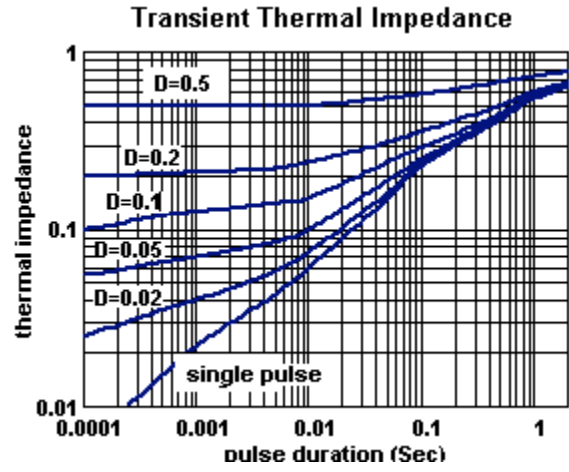
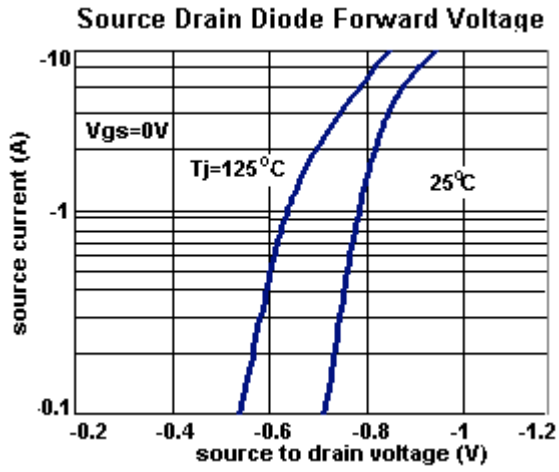

Marking Indication

P/N: TSM2301CX
Package: SOT-23

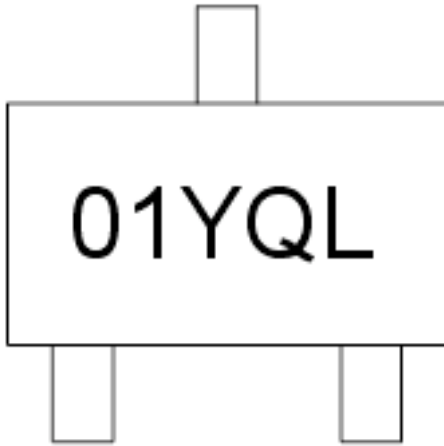

* 01 = Product code for TSM2301

* YQL = Date Code

Y = Year Code

Q = Quarter Code (Q1=A, Q2=B, Q3=C, Q4=D)

L = Lot Number

SOT-23 Mechanical Drawing

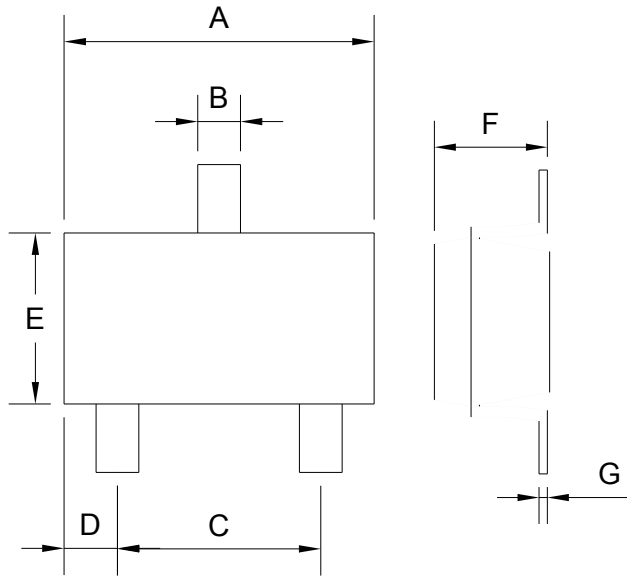

SOT-23 DIMENSION				
DIM	MILLIMETERS		INCHES	
	MIN	MAX	MIN	MAX
A	2.88	2.91	0.113	0.115
B	0.39	0.42	0.015	0.017
C	1.78	2.03	0.070	0.080
D	0.51	0.61	0.020	0.024
E	1.59	1.66	0.063	0.065
F	1.04	1.08	0.041	0.043
G	0.07	0.09	0.003	0.004