



Is Now Part of



ON Semiconductor®

To learn more about ON Semiconductor, please visit our website at
www.onsemi.com

ON Semiconductor and the ON Semiconductor logo are trademarks of Semiconductor Components Industries, LLC dba ON Semiconductor or its subsidiaries in the United States and/or other countries. ON Semiconductor owns the rights to a number of patents, trademarks, copyrights, trade secrets, and other intellectual property. A listing of ON Semiconductor's product/patent coverage may be accessed at www.onsemi.com/site/pdf/Patent-Marking.pdf. ON Semiconductor reserves the right to make changes without further notice to any products herein. ON Semiconductor makes no warranty, representation or guarantee regarding the suitability of its products for any particular purpose, nor does ON Semiconductor assume any liability arising out of the application or use of any product or circuit, and specifically disclaims any and all liability, including without limitation special, consequential or incidental damages. Buyer is responsible for its products and applications using ON Semiconductor products, including compliance with all laws, regulations and safety requirements or standards, regardless of any support or applications information provided by ON Semiconductor. "Typical" parameters which may be provided in ON Semiconductor data sheets and/or specifications can and do vary in different applications and actual performance may vary over time. All operating parameters, including "Typicals" must be validated for each customer application by customer's technical experts. ON Semiconductor does not convey any license under its patent rights nor the rights of others. ON Semiconductor products are not designed, intended, or authorized for use as a critical component in life support systems or any FDA Class 3 medical devices or medical devices with a same or similar classification in a foreign jurisdiction or any devices intended for implantation in the human body. Should Buyer purchase or use ON Semiconductor products for any such unintended or unauthorized application, Buyer shall indemnify and hold ON Semiconductor and its officers, employees, subsidiaries, affiliates, and distributors harmless against all claims, costs, damages, and expenses, and reasonable attorney fees arising out of, directly or indirectly, any claim of personal injury or death associated with such unintended or unauthorized use, even if such claim alleges that ON Semiconductor was negligent regarding the design or manufacture of the part. ON Semiconductor is an Equal Opportunity/Affirmative Action Employer. This literature is subject to all applicable copyright laws and is not for resale in any manner.



FDD86102

N-Channel Shielded Gate PowerTrench[®] MOSFET

100 V, 36 A, 24 mΩ

Features

- Shielded Gate MOSFET Technology
- Max $r_{DS(on)}$ = 24 mΩ at $V_{GS} = 10\text{ V}$, $I_D = 8\text{ A}$
- Max $r_{DS(on)}$ = 38 mΩ at $V_{GS} = 6\text{ V}$, $I_D = 6\text{ A}$
- High performance trench technology for extremely low $r_{DS(on)}$
- High power and current handling capability in a widely used surface mount package
- Very low Q_g and Q_{gd} compared to competing trench technologies
- Fast switching speed
- 100% UIL tested
- RoHS Compliant



General Description

This N-Channel MOSFET is produced using Fairchild Semiconductor's advanced PowerTrench[®] process that incorporates Shielded Gate technology. This process has been optimized for $r_{DS(on)}$, switching performance and ruggedness.

Application

- DC - DC Conversion

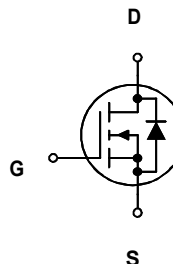
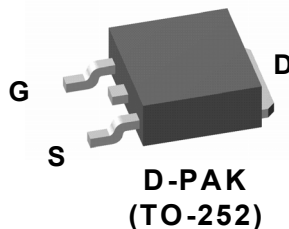

MOSFET Maximum Ratings $T_C = 25\text{ °C}$ unless otherwise noted

Symbol	Parameter	Ratings	Units
V_{DS}	Drain to Source Voltage	100	V
V_{GS}	Gate to Source Voltage	±20	V
I_D	Drain Current -Continuous $T_C = 25\text{ °C}$	36	A
	-Continuous $T_A = 25\text{ °C}$ (Note 1a)	8	
	-Pulsed (Note 4)	75	
E_{AS}	Single Pulse Avalanche Energy (Note 3)	121	mJ
P_D	Power Dissipation $T_C = 25\text{ °C}$	62	W
	Power Dissipation $T_A = 25\text{ °C}$ (Note 1a)	3.1	
T_J, T_{STG}	Operating and Storage Junction Temperature Range	-55 to +150	°C

Thermal Characteristics

$R_{\theta JC}$	Thermal Resistance, Junction to Case	2.0	°C/W
$R_{\theta JA}$	Thermal Resistance, Junction to Ambient (Note 1a)	40	

Package Marking and Ordering Information

Device Marking	Device	Package	Reel Size	Tape Width	Quantity
FDD86102	FDD86102	D-PAK(TO-252)	13 "	16 mm	2500 units

Electrical Characteristics $T_J = 25\text{ }^\circ\text{C}$ unless otherwise noted

Symbol	Parameter	Test Conditions	Min	Typ	Max	Units
--------	-----------	-----------------	-----	-----	-----	-------

Off Characteristics

BV_{DSS}	Drain to Source Breakdown Voltage	$I_D = 250\text{ }\mu\text{A}$, $V_{GS} = 0\text{ V}$	100			V
$\frac{\Delta BV_{DSS}}{\Delta T_J}$	Breakdown Voltage Temperature Coefficient	$I_D = 250\text{ }\mu\text{A}$, referenced to $25\text{ }^\circ\text{C}$		67		mV/ $^\circ\text{C}$
I_{DSS}	Zero Gate Voltage Drain Current	$V_{DS} = 80\text{ V}$, $V_{GS} = 0\text{ V}$			1	μA
I_{GSS}	Gate to Source Leakage Current	$V_{GS} = \pm 20\text{ V}$, $V_{DS} = 0\text{ V}$			± 100	nA

On Characteristics (Note 2)

$V_{GS(th)}$	Gate to Source Threshold Voltage	$V_{GS} = V_{DS}$, $I_D = 250\text{ }\mu\text{A}$	2	3.1	4	V
$\frac{\Delta V_{GS(th)}}{\Delta T_J}$	Gate to Source Threshold Voltage Temperature Coefficient	$I_D = 250\text{ }\mu\text{A}$, referenced to $25\text{ }^\circ\text{C}$		-8.5		mV/ $^\circ\text{C}$
$r_{DS(on)}$	Static Drain to Source On Resistance	$V_{GS} = 10\text{ V}$, $I_D = 8\text{ A}$		19	24	m Ω
		$V_{GS} = 6\text{ V}$, $I_D = 6\text{ A}$		26	38	
		$V_{GS} = 10\text{ V}$, $I_D = 8\text{ A}$, $T_J = 125\text{ }^\circ\text{C}$		33	44	
g_{FS}	Forward Transconductance	$V_{DS} = 10\text{ V}$, $I_D = 8\text{ A}$		21		S

Dynamic Characteristics

C_{iss}	Input Capacitance	$V_{DS} = 50\text{ V}$, $V_{GS} = 0\text{ V}$, $f = 1\text{ MHz}$		780	1035	pF
C_{oss}	Output Capacitance			180	240	pF
C_{riss}	Reverse Transfer Capacitance			15	25	pF
R_g	Gate Resistance			0.4		Ω

Switching Characteristics

$t_{d(on)}$	Turn-On Delay Time	$V_{DD} = 50\text{ V}$, $I_D = 8\text{ A}$, $V_{GS} = 10\text{ V}$, $R_{GEN} = 6\text{ }\Omega$		7.6	15	ns
t_r	Rise Time			3	10	ns
$t_{d(off)}$	Turn-Off Delay Time			13.4	24	ns
t_f	Fall Time			2.9	10	ns
Q_g	Total Gate Charge		$V_{GS} = 0\text{ V to } 10\text{ V}$	13.4	19	nC
Q_g	Total Gate Charge	$V_{GS} = 0\text{ V to } 5\text{ V}$	7.6	11	nC	
Q_{gs}	Gate to Source Gate Charge	$V_{DD} = 50\text{ V}$, $I_D = 8\text{ A}$		4.0		nC
Q_{gd}	Gate to Drain "Miller" Charge			3.7		nC

Drain-Source Diode Characteristics

V_{SD}	Source to Drain Diode Forward Voltage	$V_{GS} = 0\text{ V}$, $I_S = 8\text{ A}$ (Note 2)		0.8	1.3	V
		$V_{GS} = 0\text{ V}$, $I_S = 2.6\text{ A}$ (Note 2)		0.7	1.2	
t_{rr}	Reverse Recovery Time	$I_F = 8\text{ A}$, $di/dt = 100\text{ A}/\mu\text{s}$		43	68	ns
Q_{rr}	Reverse Recovery Charge			43	68	nC

Notes:

- $R_{\theta JA}$ is the sum of the junction-to-case and case-to-ambient thermal resistance where the case thermal reference is defined as the solder mounting surface of the drain pins. $R_{\theta JC}$ is guaranteed by design while $R_{\theta JA}$ is determined by the user's board design.

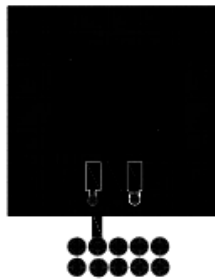

a. $40\text{ }^\circ\text{C/W}$ when mounted on a 1 in^2 pad of 2 oz copper.



b. $96\text{ }^\circ\text{C/W}$ when mounted on a minimum pad of 2 oz copper.

2. Pulse Test: Pulse Width < $300\text{ }\mu\text{s}$, Duty cycle < 2.0%.

3. E_{AS} 121 mJ is based on starting $T_J = 25\text{ }^\circ\text{C}$, $L = 3\text{ mH}$, $I_{AS} = 9\text{ A}$, $V_{DD} = 100\text{ V}$, $V_{GS} = 10\text{ V}$. 100% test at $L = 0.1\text{ mH}$, $I_{AS} = 30\text{ A}$.

4. Pulsed Drain current is tested at $300\text{ }\mu\text{s}$ with 2% duty cycle. For repetitive pulses, the pulse width is limited by the maximum junction temperature.

Typical Characteristics $T_J = 25\text{ }^\circ\text{C}$ unless otherwise noted

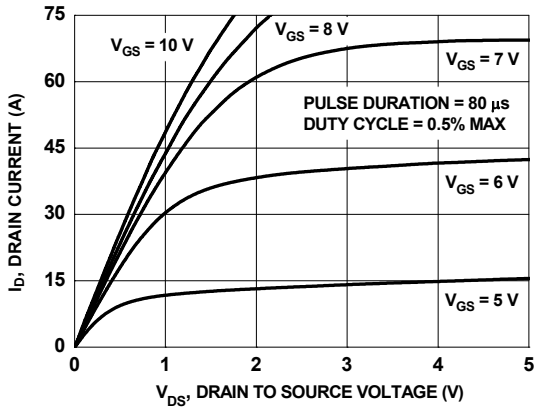

Figure 1. On-Region Characteristics

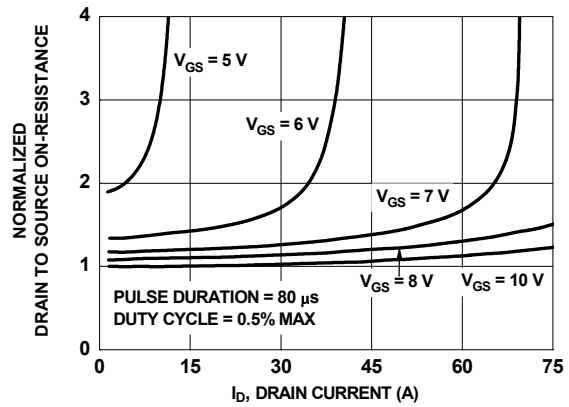

Figure 2. Normalized On-Resistance vs Drain Current and Gate Voltage

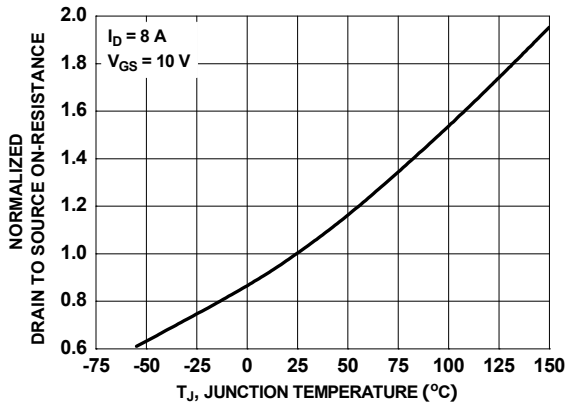

Figure 3. Normalized On-Resistance vs Junction Temperature

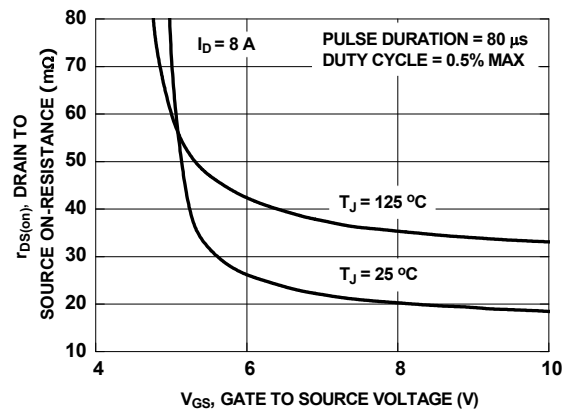

Figure 4. On-Resistance vs Gate to Source Voltage

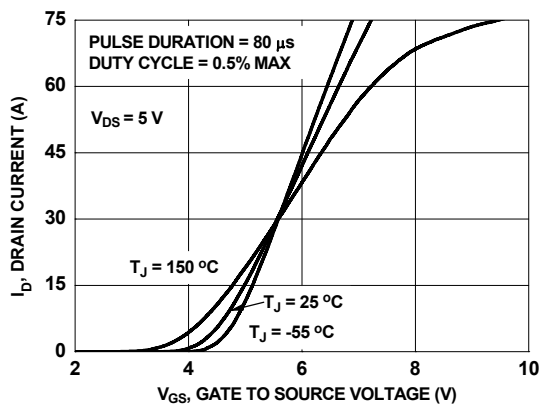

Figure 5. Transfer Characteristics

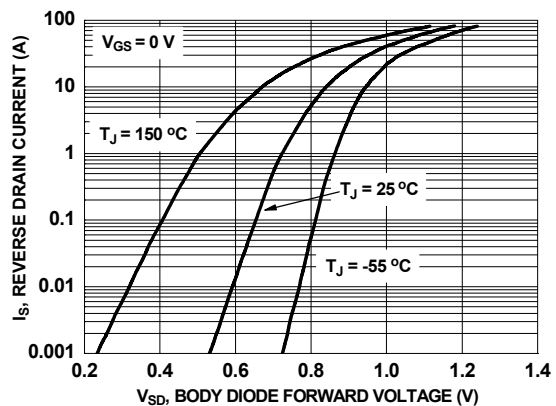

Figure 6. Source to Drain Diode Forward Voltage vs Source Current

Typical Characteristics $T_J = 25\text{ }^\circ\text{C}$ unless otherwise noted

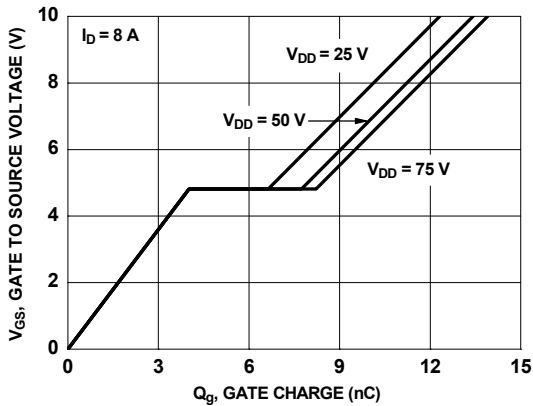

Figure 7. Gate Charge Characteristics

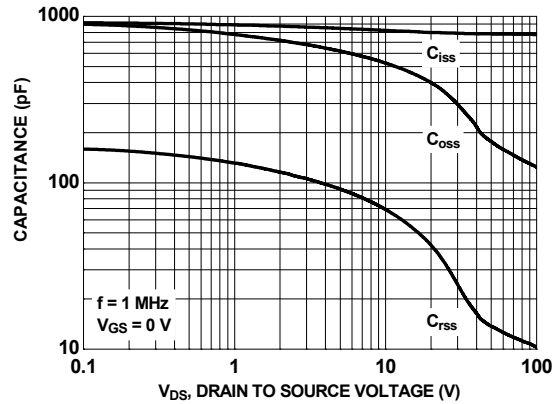

Figure 8. Capacitance vs Drain to Source Voltage

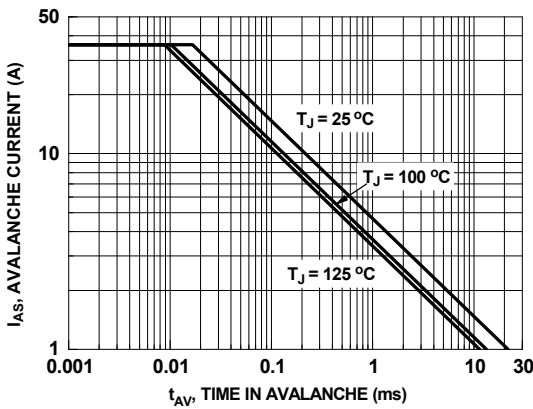

Figure 9. Unclamped Inductive Switching Capability

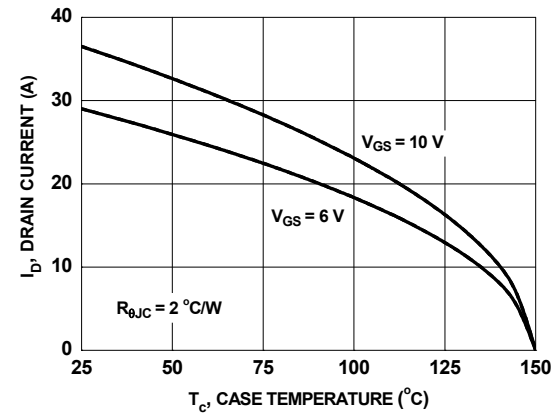

Figure 10. Maximum Continuous Drain Current vs Case Temperature

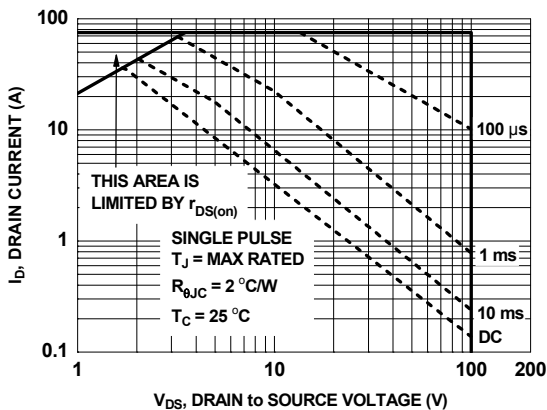

Figure 11. Forward Bias Safe Operating Area

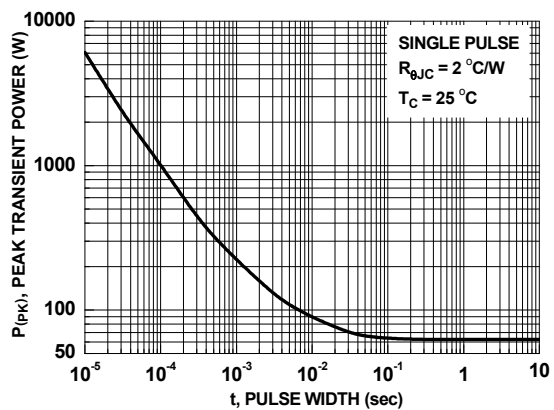

Figure 12. Single Pulse Maximum Power Dissipation

Typical Characteristics $T_J = 25\text{ }^\circ\text{C}$ unless otherwise noted

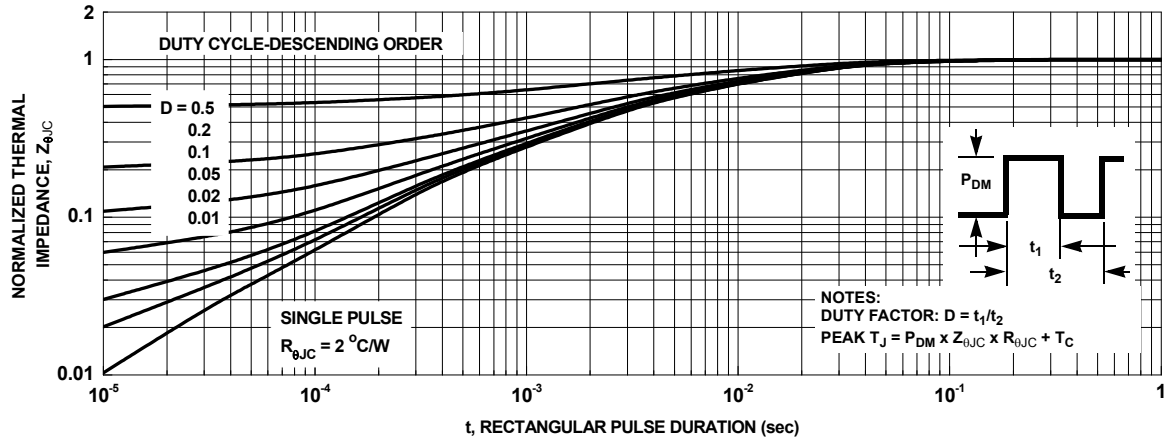
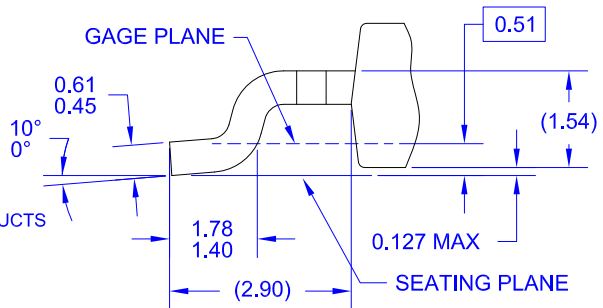

Figure 13. Junction-to-Case Transient Thermal Response Curve



NOTES: UNLESS OTHERWISE SPECIFIED

- A) THIS PACKAGE CONFORMS TO JEDEC, TO-252, ISSUE C, VARIATION AA.
- B) ALL DIMENSIONS ARE IN MILLIMETERS.
- C) DIMENSIONING AND TOLERANCING PER ASME Y14.5M-2009.
- D) SUPPLIER DEPENDENT MOLD LOCKING HOLES OR CHAMFERED CORNERS OR EDGE PROTRUSION.
- E) TRIMMED METAL CENTER LEAD IS PRESENT ON FOR NON-DIODE PRODUCTS
- F) DIMENSIONS ARE EXCLUSIVE OF BURS, MOLD FLASH AND TIE BAR EXTRUSIONS.
- G) LAND PATTERN RECOMMENDATION IS BASED ON IPC7351A STD TO228P991X239-3N.
- H) DRAWING NUMBER AND REVISION: MKT-TO252A03REV11



ON Semiconductor and  are trademarks of Semiconductor Components Industries, LLC dba ON Semiconductor or its subsidiaries in the United States and/or other countries. ON Semiconductor owns the rights to a number of patents, trademarks, copyrights, trade secrets, and other intellectual property. A listing of ON Semiconductor's product/patent coverage may be accessed at www.onsemi.com/site/pdf/Patent-Marking.pdf. ON Semiconductor reserves the right to make changes without further notice to any products herein. ON Semiconductor makes no warranty, representation or guarantee regarding the suitability of its products for any particular purpose, nor does ON Semiconductor assume any liability arising out of the application or use of any product or circuit, and specifically disclaims any and all liability, including without limitation special, consequential or incidental damages. Buyer is responsible for its products and applications using ON Semiconductor products, including compliance with all laws, regulations and safety requirements or standards, regardless of any support or applications information provided by ON Semiconductor. "Typical" parameters which may be provided in ON Semiconductor data sheets and/or specifications can and do vary in different applications and actual performance may vary over time. All operating parameters, including "Typicals" must be validated for each customer application by customer's technical experts. ON Semiconductor does not convey any license under its patent rights nor the rights of others. ON Semiconductor products are not designed, intended, or authorized for use as a critical component in life support systems or any FDA Class 3 medical devices or medical devices with a same or similar classification in a foreign jurisdiction or any devices intended for implantation in the human body. Should Buyer purchase or use ON Semiconductor products for any such unintended or unauthorized application, Buyer shall indemnify and hold ON Semiconductor and its officers, employees, subsidiaries, affiliates, and distributors harmless against all claims, costs, damages, and expenses, and reasonable attorney fees arising out of, directly or indirectly, any claim of personal injury or death associated with such unintended or unauthorized use, even if such claim alleges that ON Semiconductor was negligent regarding the design or manufacture of the part. ON Semiconductor is an Equal Opportunity/Affirmative Action Employer. This literature is subject to all applicable copyright laws and is not for resale in any manner.

PUBLICATION ORDERING INFORMATION

LITERATURE FULFILLMENT:

Literature Distribution Center for ON Semiconductor
19521 E. 32nd Pkwy, Aurora, Colorado 80011 USA
Phone: 303-675-2175 or 800-344-3860 Toll Free USA/Canada
Fax: 303-675-2176 or 800-344-3867 Toll Free USA/Canada
Email: orderlit@onsemi.com

N. American Technical Support: 800-282-9855 Toll Free
USA/Canada
Europe, Middle East and Africa Technical Support:
Phone: 421 33 790 2910
Japan Customer Focus Center
Phone: 81-3-5817-1050

ON Semiconductor Website: www.onsemi.com
Order Literature: <http://www.onsemi.com/orderlit>
For additional information, please contact your local
Sales Representative