



FDD5614P

# FDD5614P

## 60V P-Channel PowerTrench<sup>®</sup> MOSFET

### General Description

This 60V P-Channel MOSFET uses Fairchild's high voltage PowerTrench process. It has been optimized for power management applications.

### Applications

- DC/DC converter
- Power management
- Load switch

### Features

- -15 A, -60 V.  $R_{DS(ON)} = 100\text{ m}\Omega @ V_{GS} = -10\text{ V}$   
 $R_{DS(ON)} = 130\text{ m}\Omega @ V_{GS} = -4.5\text{ V}$
- Fast switching speed
- High performance trench technology for extremely low  $R_{DS(ON)}$
- High power and current handling capability

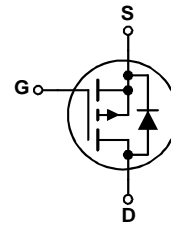
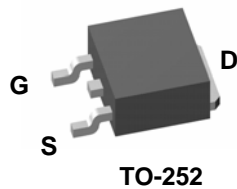

### Absolute Maximum Ratings $T_A=25^\circ\text{C}$ unless otherwise noted

Symbol	Parameter	Ratings	Units
$V_{DSS}$	Drain-Source Voltage	-60	V
$V_{GSS}$	Gate-Source Voltage	$\pm 20$	V
$I_D$	Drain Current – Continuous (Note 3)	-15	A
	– Pulsed (Note 1a)	-45	
$P_D$	Power Dissipation for Single Operation (Note 1)	42	W
	(Note 1a)	3.8	
	(Note 1b)	1.6	
$T_J, T_{STG}$	Operating and Storage Junction Temperature Range	-55 to +175	$^\circ\text{C}$

### Thermal Characteristics

$R_{\theta JC}$	Thermal Resistance, Junction-to-Case (Note 1)	3.5	$^\circ\text{C}/\text{W}$
$R_{\theta JA}$	Thermal Resistance, Junction-to-Ambient (Note 1a)	40	$^\circ\text{C}/\text{W}$
$R_{\theta JA}$	Thermal Resistance, Junction-to-Ambient (Note 1b)	96	$^\circ\text{C}/\text{W}$

### Package Marking and Ordering Information

Device Marking	Device	Reel Size	Tape width	Quantity
FDD5614P	FDD5614P	13"	16mm	2500 units

**Electrical Characteristics** $T_A = 25^\circ\text{C}$  unless otherwise noted

Symbol	Parameter	Test Conditions	Min	Typ	Max	Units
<b>Drain-Source Avalanche Ratings (Note 1)</b>						
$W_{DSS}$	Single Pulse Drain-Source Avalanche Energy	$V_{DD} = -30\text{ V}, I_D = -4.5\text{ A}$			90	mJ
$I_{AR}$	Maximum Drain-Source Avalanche Current				-4.5	A
<b>Off Characteristics</b>						
$BV_{DSS}$	Drain-Source Breakdown Voltage	$V_{GS} = 0\text{ V}, I_D = -250\text{ }\mu\text{A}$	-60			V
$\frac{\Delta BV_{DSS}}{\Delta T_J}$	Breakdown Voltage Temperature Coefficient	$I_D = -250\text{ }\mu\text{A}$ , Referenced to $25^\circ\text{C}$		-49		mV/ $^\circ\text{C}$
$I_{DSS}$	Zero Gate Voltage Drain Current	$V_{DS} = -48\text{ V}, V_{GS} = 0\text{ V}$			-1	$\mu\text{A}$
$I_{GSSF}$	Gate-Body Leakage, Forward	$V_{GS} = 20\text{ V}, V_{DS} = 0\text{ V}$			100	nA
$I_{GSSR}$	Gate-Body Leakage, Reverse	$V_{GS} = -20\text{ V}, V_{DS} = 0\text{ V}$			-100	nA
<b>On Characteristics (Note 2)</b>						
$V_{GS(th)}$	Gate Threshold Voltage	$V_{DS} = V_{GS}, I_D = -250\text{ }\mu\text{A}$	-1	-1.6	-3	V
$\frac{\Delta V_{GS(th)}}{\Delta T_J}$	Gate Threshold Voltage Temperature Coefficient	$I_D = -250\text{ }\mu\text{A}$ , Referenced to $25^\circ\text{C}$		4		mV/ $^\circ\text{C}$
$R_{DS(on)}$	Static Drain-Source On-Resistance	$V_{GS} = -10\text{ V}, I_D = -4.5\text{ A}$ $V_{GS} = -4.5\text{ V}, I_D = -3.9\text{ A}$ $V_{GS} = -10\text{ V}, I_D = -4.5\text{ A}, T_J = 125^\circ\text{C}$		76 99 137	100 130 185	m $\Omega$
$I_{D(on)}$	On-State Drain Current	$V_{GS} = -10\text{ V}, V_{DS} = -5\text{ V}$	-20			A
$g_{FS}$	Forward Transconductance	$V_{DS} = -5\text{ V}, I_D = -3\text{ A}$		8		S
<b>Dynamic Characteristics</b>						
$C_{iss}$	Input Capacitance	$V_{DS} = -30\text{ V}, V_{GS} = 0\text{ V},$		759		pF
$C_{oss}$	Output Capacitance	$f = 1.0\text{ MHz}$		90		pF
$C_{riss}$	Reverse Transfer Capacitance			39		pF
<b>Switching Characteristics (Note 2)</b>						
$t_{d(on)}$	Turn-On Delay Time	$V_{DD} = -30\text{ V}, I_D = -1\text{ A},$		7	14	ns
$t_r$	Turn-On Rise Time	$V_{GS} = -10\text{ V}, R_{GEN} = 6\text{ }\Omega$		10	20	ns
$t_{d(off)}$	Turn-Off Delay Time			19	34	ns
$t_f$	Turn-Off Fall Time			12	22	ns
$Q_g$	Total Gate Charge	$V_{DS} = -30\text{ V}, I_D = -4.5\text{ A},$		15	24	nC
$Q_{gs}$	Gate-Source Charge	$V_{GS} = -10\text{ V}$		2.5		nC
$Q_{gd}$	Gate-Drain Charge			3.0		nC
<b>Drain-Source Diode Characteristics and Maximum Ratings</b>						
$I_S$	Maximum Continuous Drain-Source Diode Forward Current				-3.2	A
$V_{SD}$	Drain-Source Diode Forward Voltage	$V_{GS} = 0\text{ V}, I_S = -3.2\text{ A}$ (Note 2)		-0.8	-1.2	V

**Notes:**

1.  $R_{\theta JA}$  is the sum of the junction-to-case and case-to-ambient thermal resistance where the case thermal reference is defined as the solder mounting surface of the drain pins.  $R_{\theta JC}$  is guaranteed by design while  $R_{\theta CA}$  is determined by the user's board design.



a)  $R_{\theta JA} = 40^{\circ}\text{C/W}$  when mounted on a  $1\text{in}^2$  pad of 2 oz copper



b)  $R_{\theta JA} = 96^{\circ}\text{C/W}$  when mounted on a minimum pad.

Scale 1 : 1 on letter size paper

2. Pulse Test: Pulse Width < 300 $\mu\text{s}$ , Duty Cycle < 2.0%

3. Maximum current is calculated as: 
$$\sqrt{\frac{P_D}{R_{DS(on)}}}$$
 where  $P_D$  is maximum power dissipation at  $T_C = 25^{\circ}\text{C}$  and  $R_{DS(on)}$  is at  $T_{J(max)}$  and  $V_{GS} = 10\text{V}$ . Package current limitation is 21A

## Typical Characteristics

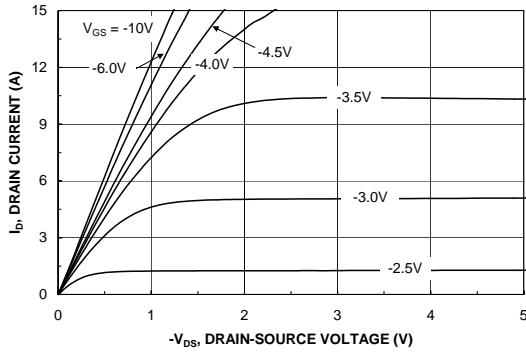

Figure 1. On-Region Characteristics.

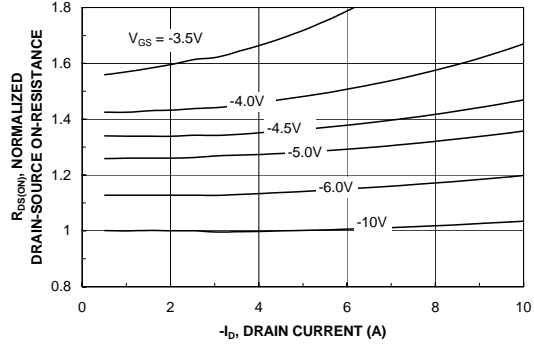

Figure 2. On-Resistance Variation with Drain Current and Gate Voltage.

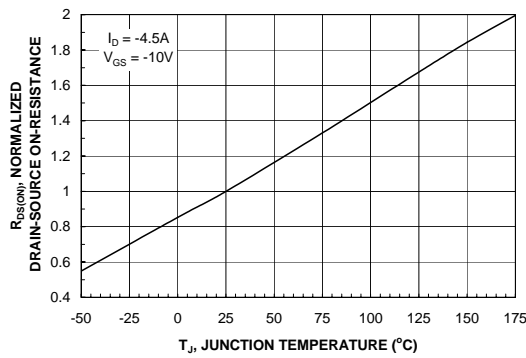

Figure 3. On-Resistance Variation with Temperature.

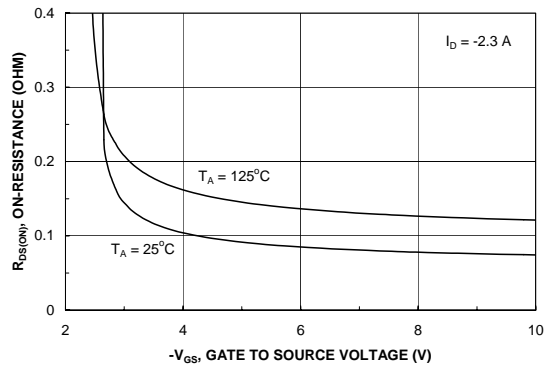

Figure 4. On-Resistance Variation with Gate-to-Source Voltage.

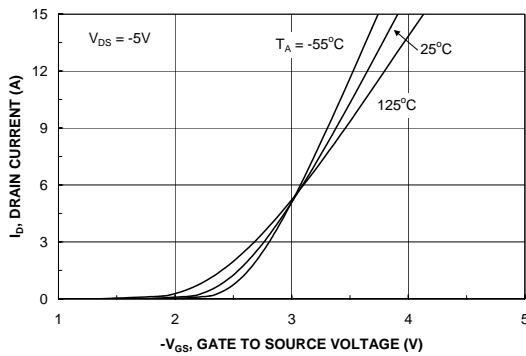

Figure 5. Transfer Characteristics.

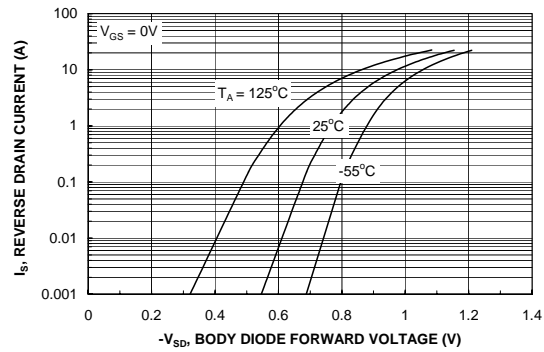

Figure 6. Body Diode Forward Voltage Variation with Source Current and Temperature.

Typical Characteristics

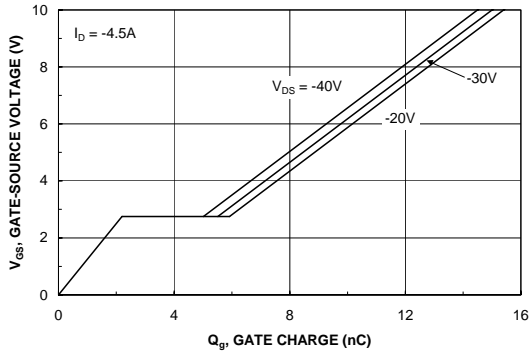

Figure 7. Gate Charge Characteristics.

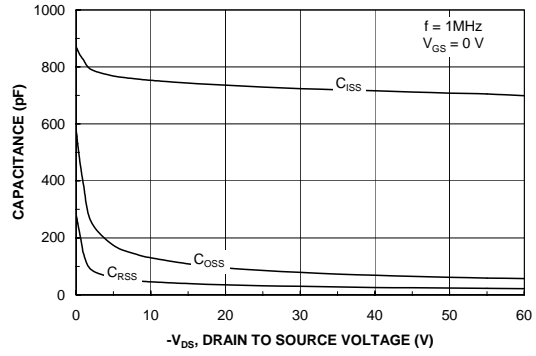

Figure 8. Capacitance Characteristics.

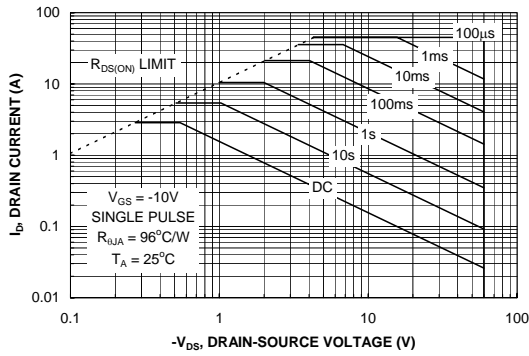

Figure 9. Maximum Safe Operating Area.

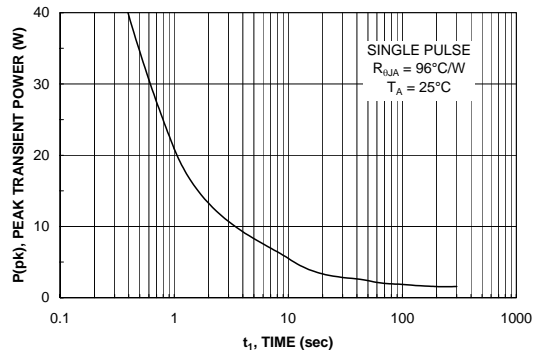

Figure 10. Single Pulse Maximum Power Dissipation.

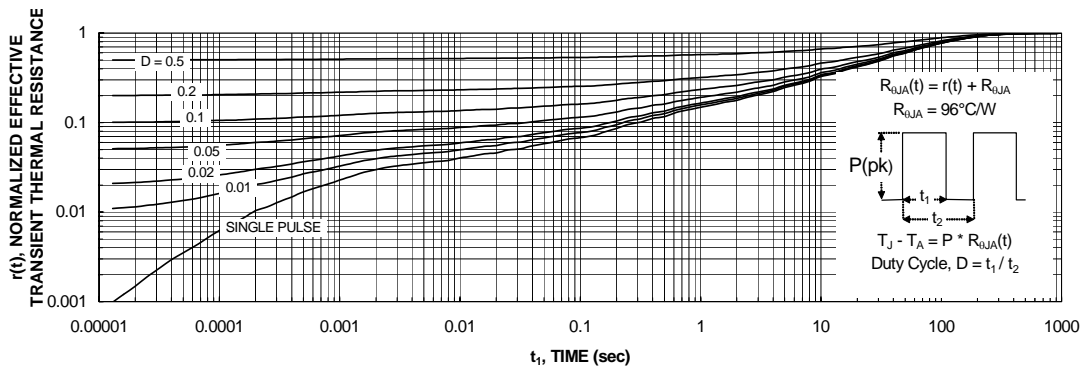
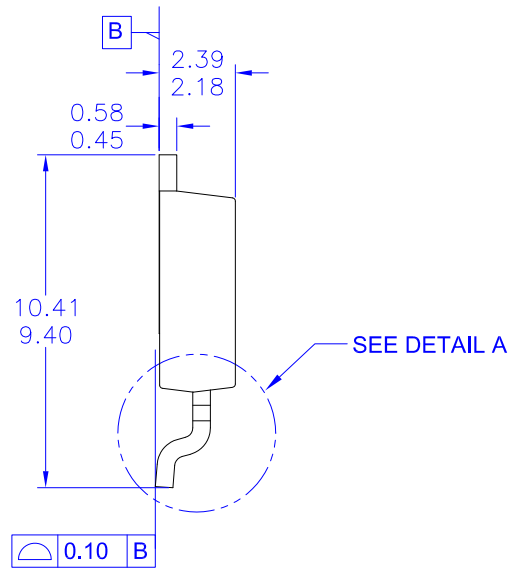
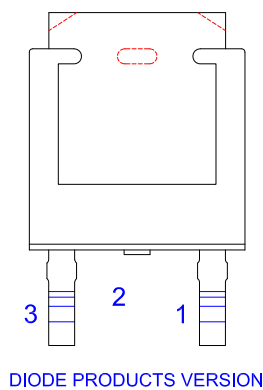
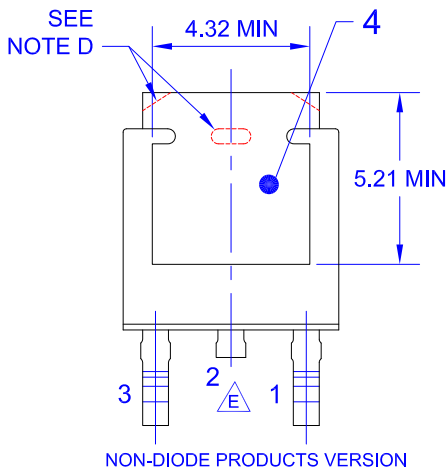
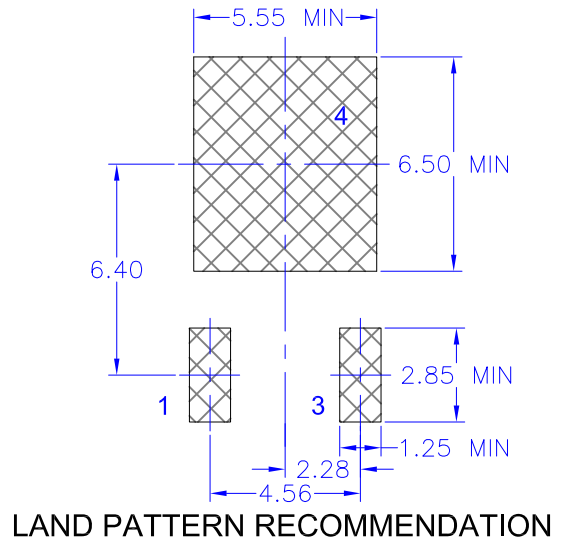
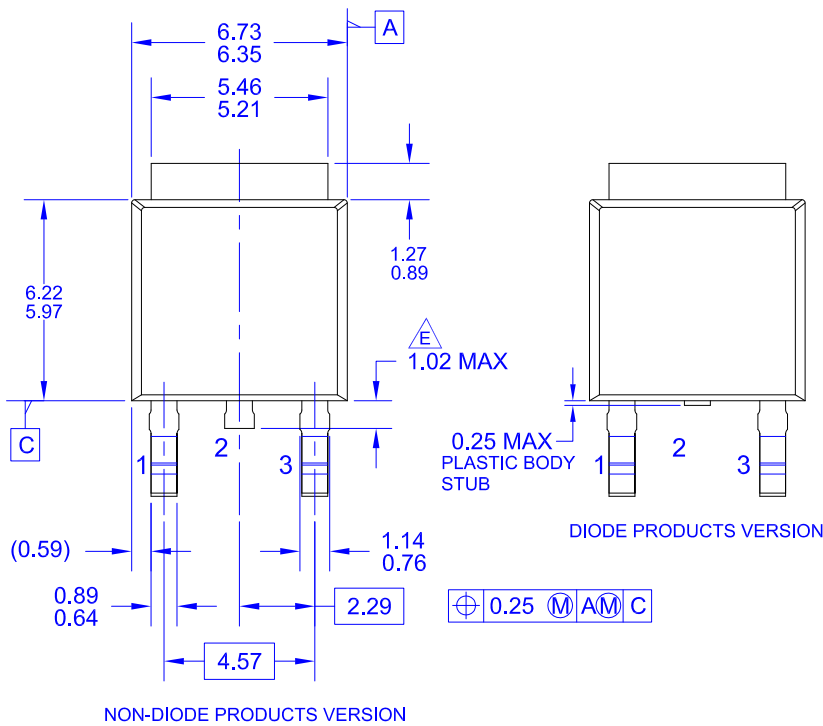

Figure 11. Transient Thermal Response Curve.

Thermal characterization performed using the conditions described in Note 1b. Transient thermal response will change depending on the circuit board design.



NOTES: UNLESS OTHERWISE SPECIFIED

- A) THIS PACKAGE CONFORMS TO JEDEC, TO-252, ISSUE C, VARIATION AA.
- B) ALL DIMENSIONS ARE IN MILLIMETERS.
- C) DIMENSIONING AND TOLERANCING PER ASME Y14.5M-2009.
- D) SUPPLIER DEPENDENT MOLD LOCKING HOLES OR CHAMFERED CORNERS OR EDGE PROTRUSION.
- E) TRIMMED CENTER LEAD IS PRESENT ONLY FOR DIODE PRODUCTS
- F) DIMENSIONS ARE EXCLUSIVE OF BURRS, MOLD FLASH AND TIE BAR EXTRUSIONS.
- G) LAND PATTERN RECOMMENDATION IS BASED ON IPC7351A STD TO228P991X239-3N.
- H) DRAWING NUMBER AND REVISION: MKT-TO252A03REV10

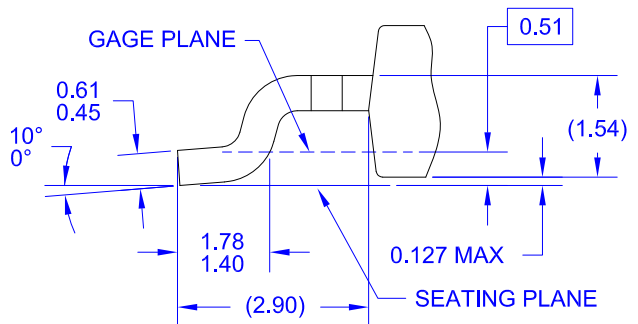

DETAIL A  
(ROTATED -90°)  
SCALE: 12X







### TRADEMARKS

The following includes registered and unregistered trademarks and service marks, owned by Fairchild Semiconductor and/or its global subsidiaries, and is not intended to be an exhaustive list of all such trademarks.

AccuPower™  
 AttitudeEngine™  
 Awinda®  
 AX-CAP®\*  
 BitSiC™  
 Build it Now™  
 CorePLUS™  
 CorePOWER™  
 CROSSVOL™  
 CTL™  
 Current Transfer Logic™  
 DEUXPEED®  
 Dual Cool™  
 EcoSPARK®  
 EfficientMax™  
 ESBC™  
 F®  
 Fairchild®  
 Fairchild Semiconductor®  
 FACT Quiet Series™  
 FACT®  
 FAST®  
 FastvCore™  
 FETBench™  
 FPS™

F-PFS™  
 FRFET®  
 Global Power Resource™  
 GreenBridge™  
 Green FPS™  
 Green FPS™ e-Series™  
 Gmax™  
 GTO™  
 IntelliMAX™  
 ISOPLANAR™  
 Making Small Speakers Sound Louder and Better™  
 MegaBuck™  
 MICROCOUPLER™  
 MicroFET™  
 MicroPak™  
 MicroPak2™  
 MillerDrive™  
 MotionMax™  
 MotionGrid®  
 MTI®  
 MTX®  
 MVN®  
 mWSaver®  
 OptoHiT™  
 OPTOLOGIC®

OPTOPLANAR®  
  
 Power Supply WebDesigner™  
 PowerTrench®  
 PowerXS™  
 Programmable Active Droop™  
 QFET®  
 QS™  
 Quiet Series™  
 RapidConfigure™  
  
 Saving our world, 1mW/W/kW at a time™  
 SignalWise™  
 SmartMax™  
 SMART START™  
 Solutions for Your Success™  
 SPM®  
 STEALTH™  
 SuperFET®  
 SuperSOT™-3  
 SuperSOT™-6  
 SuperSOT™-8  
 SupreMOS®  
 SyncFET™  
 Sync-Lock™

  
 TinyBoost®  
 TinyBuck®  
 TinyCalc™  
 TinyLogic®  
 TINYOPTO™  
 TinyPower™  
 TinyPWM™  
 TinyWire™  
 TranSiC™  
 TriFault Detect™  
 TRUECURRENT®\*  
 μSerDes™  
  
 UHC®  
 Ultra FRFET™  
 UniFET™  
 VCX™  
 VisualMax™  
 VoltagePlus™  
 XS™  
 Xsens™  
 仙童™

\* Trademarks of System General Corporation, used under license by Fairchild Semiconductor.

### DISCLAIMER

FAIRCHILD SEMICONDUCTOR RESERVES THE RIGHT TO MAKE CHANGES WITHOUT FURTHER NOTICE TO ANY PRODUCTS HEREIN TO IMPROVE RELIABILITY, FUNCTION, OR DESIGN. TO OBTAIN THE LATEST, MOST UP-TO-DATE DATASHEET AND PRODUCT INFORMATION, VISIT OUR WEBSITE AT [HTTP://WWW.FAIRCHILDSEMI.COM](http://www.fairchildsemi.com). FAIRCHILD DOES NOT ASSUME ANY LIABILITY ARISING OUT OF THE APPLICATION OR USE OF ANY PRODUCT OR CIRCUIT DESCRIBED HEREIN; NEITHER DOES IT CONVEY ANY LICENSE UNDER ITS PATENT RIGHTS, NOR THE RIGHTS OF OTHERS. THESE SPECIFICATIONS DO NOT EXPAND THE TERMS OF FAIRCHILD'S WORLDWIDE TERMS AND CONDITIONS, SPECIFICALLY THE WARRANTY THEREIN, WHICH COVERS THESE PRODUCTS.

### LIFE SUPPORT POLICY

FAIRCHILD'S PRODUCTS ARE NOT AUTHORIZED FOR USE AS CRITICAL COMPONENTS IN LIFE SUPPORT DEVICES OR SYSTEMS WITHOUT THE EXPRESS WRITTEN APPROVAL OF FAIRCHILD SEMICONDUCTOR CORPORATION.

As used herein:

1. Life support devices or systems are devices or systems which, (a) are intended for surgical implant into the body or (b) support or sustain life, and (c) whose failure to perform when properly used in accordance with instructions for use provided in the labeling, can be reasonably expected to result in a significant injury of the user.
2. A critical component in any component of a life support, device, or system whose failure to perform can be reasonably expected to cause the failure of the life support device or system, or to affect its safety or effectiveness.

### ANTI-COUNTERFEITING POLICY

Fairchild Semiconductor Corporation's Anti-Counterfeiting Policy. Fairchild's Anti-Counterfeiting Policy is also stated on our external website, [www.fairchildsemi.com](http://www.fairchildsemi.com), under Sales Support.

Counterfeiting of semiconductor parts is a growing problem in the industry. All manufacturers of semiconductor products are experiencing counterfeiting of their parts. Customers who inadvertently purchase counterfeit parts experience many problems such as loss of brand reputation, substandard performance, failed applications, and increased cost of production and manufacturing delays. Fairchild is taking strong measures to protect ourselves and our customers from the proliferation of counterfeit parts. Fairchild strongly encourages customers to purchase Fairchild parts either directly from Fairchild or from Authorized Fairchild Distributors who are listed by country on our web page cited above. Products customers buy either from Fairchild directly or from Authorized Fairchild Distributors are genuine parts, have full traceability, meet Fairchild's quality standards for handling and storage and provide access to Fairchild's full range of up-to-date technical and product information. Fairchild and our Authorized Distributors will stand behind all warranties and will appropriately address any warranty issues that may arise. Fairchild will not provide any warranty coverage or other assistance for parts bought from Unauthorized Sources. Fairchild is committed to combat this global problem and encourage our customers to do their part in stopping this practice by buying direct or from authorized distributors.

### PRODUCT STATUS DEFINITIONS

#### Definition of Terms

Datasheet Identification	Product Status	Definition
Advance Information	Formative / In Design	Datasheet contains the design specifications for product development. Specifications may change in any manner without notice.
Preliminary	First Production	Datasheet contains preliminary data; supplementary data will be published at a later date. Fairchild Semiconductor reserves the right to make changes at any time without notice to improve design.
No Identification Needed	Full Production	Datasheet contains final specifications. Fairchild Semiconductor reserves the right to make changes at any time without notice to improve the design.
Obsolete	Not In Production	Datasheet contains specifications on a product that is discontinued by Fairchild Semiconductor. The datasheet is for reference information only.

Rev. I74

# Mouser Electronics

Authorized Distributor

Click to View Pricing, Inventory, Delivery & Lifecycle Information:

[Fairchild Semiconductor:](#)

[FDD5614P](#)