

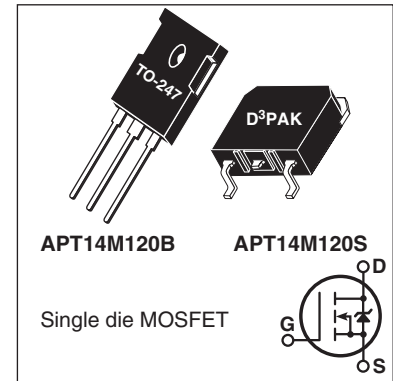

N-Channel MOSFET

Power MOS 8™ is a high speed, high voltage N-channel switch-mode power MOSFET. A proprietary planar stripe design yields excellent reliability and manufacturability. Low switching loss is achieved with low input capacitance and ultra low C_{rss} "Miller" capacitance. The intrinsic gate resistance and capacitance of the poly-silicon gate structure help control slew rates during switching, resulting in low EMI and reliable paralleling, even when switching at very high frequency. Reliability in flyback, boost, forward, and other circuits is enhanced by the high avalanche energy capability.



FEATURES

- Fast switching with low EMI/RFI
- Low $R_{DS(on)}$
- Ultra low C_{rss} for improved noise immunity
- Low gate charge
- Avalanche energy rated
- RoHS compliant 

TYPICAL APPLICATIONS

- PFC and other boost converter
- Buck converter
- Two switch forward (asymmetrical bridge)
- Single switch forward
- Flyback
- Inverters

Absolute Maximum Ratings

Symbol	Parameter	Ratings	Unit
I_D	Continuous Drain Current @ $T_C = 25^\circ\text{C}$	14	A
	Continuous Drain Current @ $T_C = 100^\circ\text{C}$	9	
I_{DM}	Pulsed Drain Current ^①	51	
V_{GS}	Gate-Source Voltage	±30	V
E_{AS}	Single Pulse Avalanche Energy ^②	1070	mJ
I_{AR}	Avalanche Current, Repetitive or Non-Repetitive	7	A

Thermal and Mechanical Characteristics

Symbol	Characteristic	Min	Typ	Max	Unit
P_D	Total Power Dissipation @ $T_C = 25^\circ\text{C}$			625	W
$R_{\theta JC}$	Junction to Case Thermal Resistance			0.20	$^\circ\text{C/W}$
$R_{\theta CS}$	Case to Sink Thermal Resistance, Flat, Greased Surface		0.11		
T_J, T_{STG}	Operating and Storage Junction Temperature Range	-55		150	$^\circ\text{C}$
T_L	Soldering Temperature for 10 Seconds (1.6mm from case)			300	
W_T	Package Weight		0.22		oz
			6.2		g
Torque	Mounting Torque (TO-247 Package), 6-32 or M3 screw			10	in-lbf
				1.1	N-m

Static Characteristics
T_J = 25°C unless otherwise specified
APT14M120B_S

Symbol	Parameter	Test Conditions	Min	Typ	Max	Unit
V _{BR(DSS)}	Drain-Source Breakdown Voltage	V _{GS} = 0V, I _D = 250μA	1200			V
ΔV _{BR(DSS)} /ΔT _J	Breakdown Voltage Temperature Coefficient	Reference to 25°C, I _D = 250μA		1.41		V/°C
R _{DS(on)}	Drain-Source On Resistance ^③	V _{GS} = 10V, I _D = 7A		0.87	1.10	Ω
V _{GS(th)}	Gate-Source Threshold Voltage	V _{GS} = V _{DS} , I _D = 1mA	3	4	5	V
ΔV _{GS(th)} /ΔT _J	Threshold Voltage Temperature Coefficient			-10		mV/°C
I _{DSS}	Zero Gate Voltage Drain Current	V _{DS} = 1200V V _{GS} = 0V			100	μA
		T _J = 25°C T _J = 125°C			500	
I _{GSS}	Gate-Source Leakage Current	V _{GS} = ±30V			±100	nA

Dynamic Characteristics
T_J = 25°C unless otherwise specified

Symbol	Parameter	Test Conditions	Min	Typ	Max	Unit
g _{fs}	Forward Transconductance	V _{DS} = 50V, I _D = 7A		15		S
C _{iss}	Input Capacitance	V _{GS} = 0V, V _{DS} = 25V f = 1MHz		4765		pF
C _{rss}	Reverse Transfer Capacitance			55		
C _{oss}	Output Capacitance			350		
C _{o(cr)} ^④	Effective Output Capacitance, Charge Related	V _{GS} = 0V, V _{DS} = 0V to 800V		135		pF
C _{o(er)} ^⑤	Effective Output Capacitance, Energy Related			70		
Q _g	Total Gate Charge	V _{GS} = 0 to 10V, I _D = 7A, V _{DS} = 600V		145		nC
Q _{gs}	Gate-Source Charge			24		
Q _{gd}	Gate-Drain Charge			70		
t _{d(on)}	Turn-On Delay Time	Resistive Switching V _{DD} = 800V, I _D = 7A R _G = 4.7Ω ^⑥ , V _{GG} = 15V		26		ns
t _r	Current Rise Time			15		
t _{d(off)}	Turn-Off Delay Time			85		
t _f	Current Fall Time			24		

Source-Drain Diode Characteristics

Symbol	Parameter	Test Conditions	Min	Typ	Max	Unit
I _S	Continuous Source Current (Body Diode)	MOSFET symbol showing the integral reverse p-n junction diode (body diode)			14	A
I _{SM}	Pulsed Source Current (Body Diode) ^①				51	
V _{SD}	Diode Forward Voltage	I _{SD} = 7A, T _J = 25°C, V _{GS} = 0V			1.0	V
t _{rr}	Reverse Recovery Time	I _{SD} = 7A ^②		1205		ns
Q _{rr}	Reverse Recovery Charge	di _{SD} /dt = 100A/μs, T _J = 25°C		23		μC
dv/dt	Peak Recovery dv/dt	I _{SD} ≤ 7A, di/dt ≤ 1000A/μs, V _{DD} = 800V, T _J = 125°C			10	V/ns

① Repetitive Rating: Pulse width and case temperature limited by maximum junction temperature.

② Starting at T_J = 25°C, L = 43.59mH, R_G = 4.7Ω, I_{AS} = 7A.

③ Pulse test: Pulse Width < 380μs, duty cycle < 2%.

④ C_{o(cr)} is defined as a fixed capacitance with the same stored charge as C_{OSS} with V_{DS} = 67% of V_{(BR)DSS}.

⑤ C_{o(er)} is defined as a fixed capacitance with the same stored energy as C_{OSS} with V_{DS} = 67% of V_{(BR)DSS}. To calculate C_{o(er)} for any value of V_{DS} less than V_{(BR)DSS}, use this equation: C_{o(er)} = -2.17E-7/V_{DS}² + 2.63E-8/V_{DS} + 3.74E-11.

⑥ R_G is external gate resistance, not including internal gate resistance or gate driver impedance. (MIC4452)

Microsemi reserves the right to change, without notice, the specifications and information contained herein.

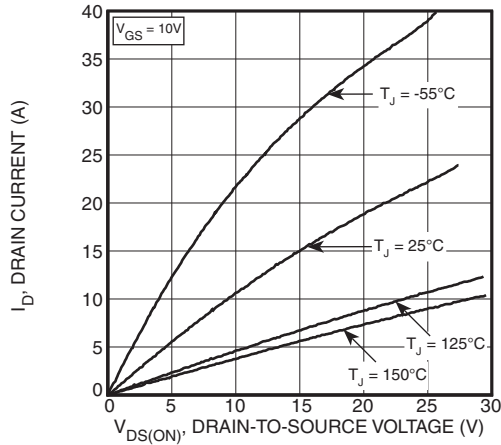

Figure 1, Output Characteristics

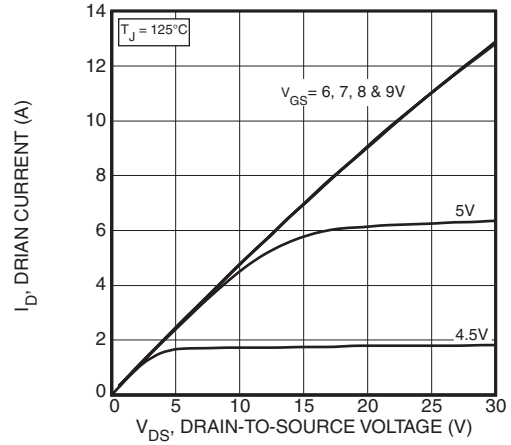

Figure 2, Output Characteristics

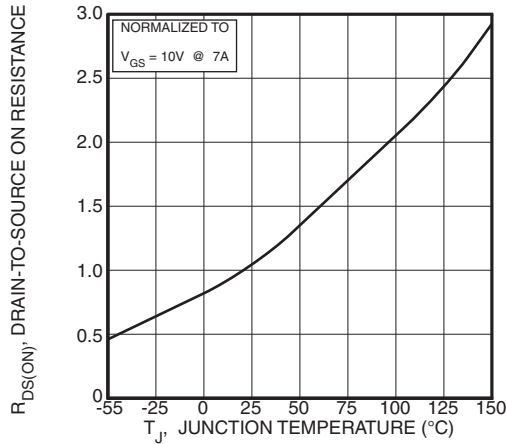

Figure 3, $R_{DS(ON)}$ vs Junction Temperature

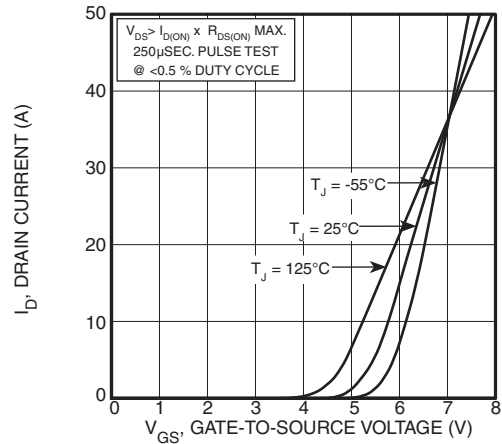

Figure 4, Transfer Characteristics

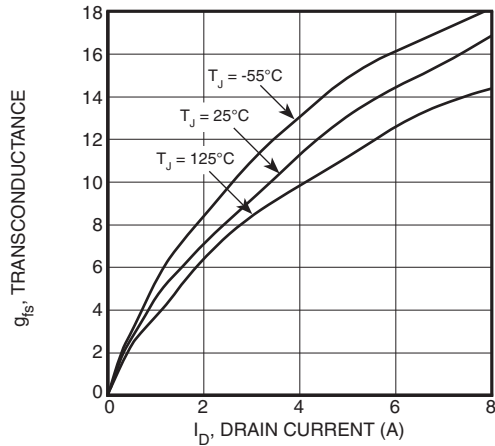

Figure 5, Gain vs Drain Current

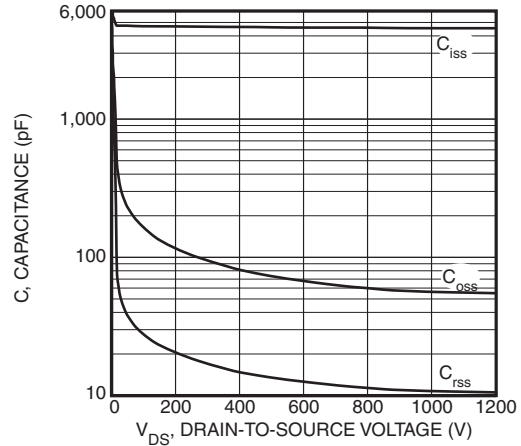

Figure 6, Capacitance vs Drain-to-Source Voltage

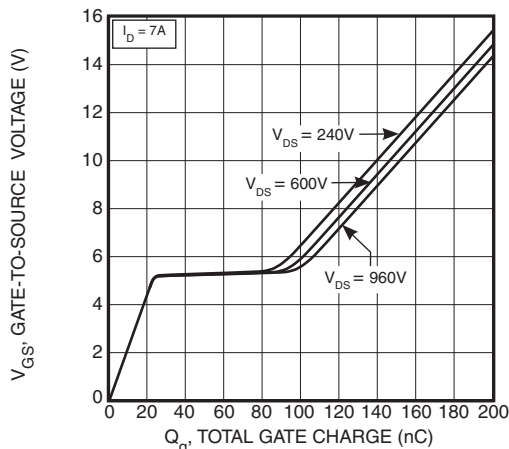

Figure 7, Gate Charge vs Gate-to-Source Voltage

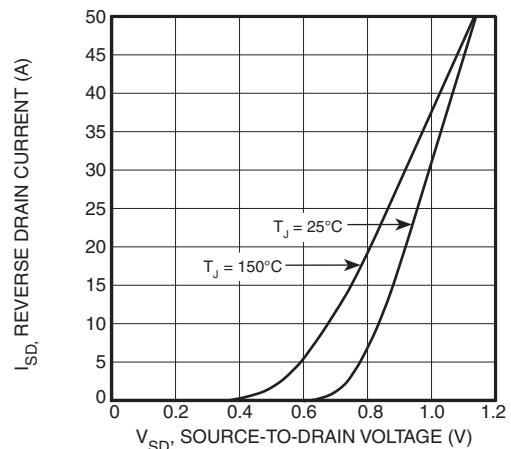

Figure 8, Reverse Drain Current vs Source-to-Drain Voltage

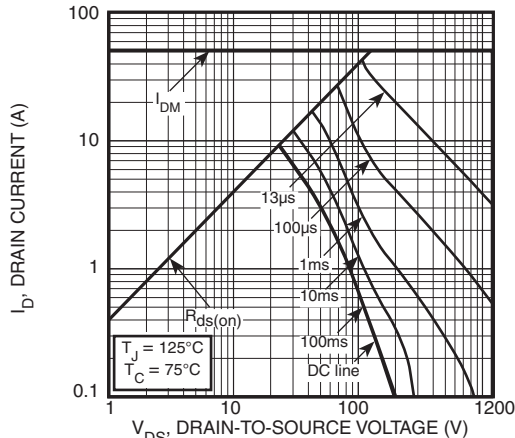

Figure 9, Forward Safe Operating Area

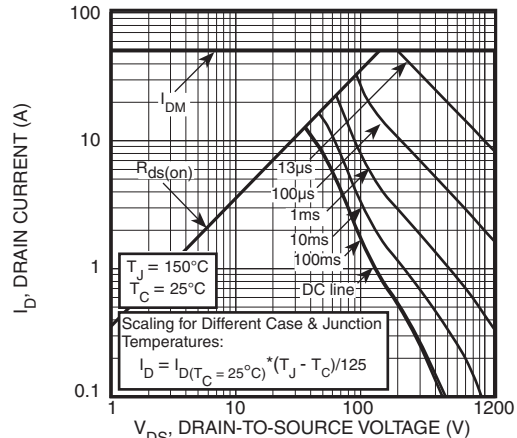

Figure 10, Maximum Forward Safe Operating Area

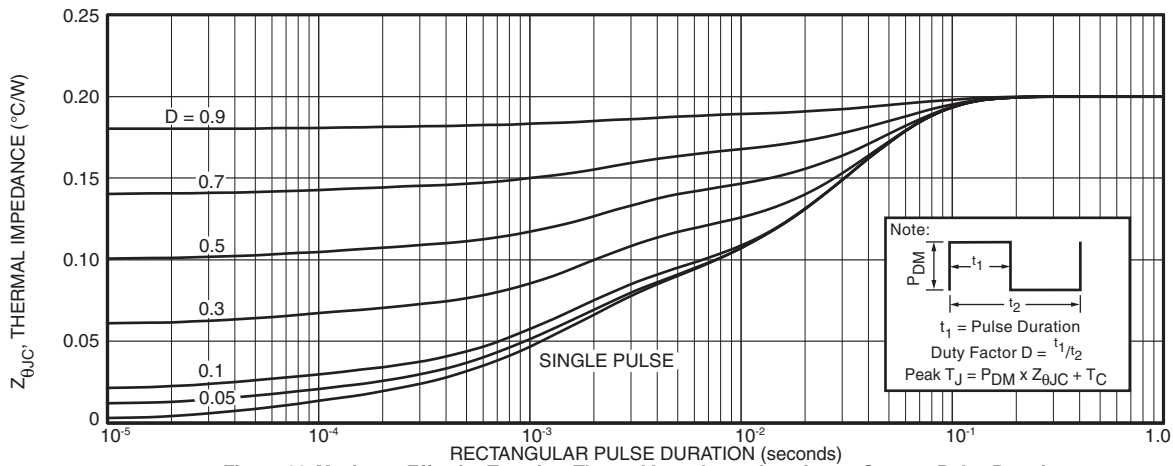
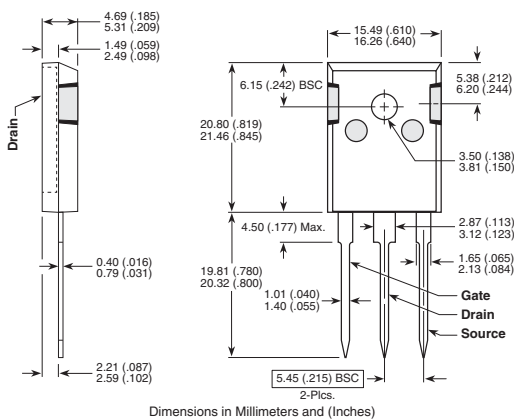

Figure 11. Maximum Effective Transient Thermal Impedance Junction-to-Case vs. Pulse Duration

TO-247 (B) Package Outline



D³PAK Package Outline

Ⓜ 100% Sn Plated

