

**富士電機株式会社** 電子カンパニー パワー半導体事業部  
 〒141-0032 東京都品川区大崎一丁目11番2号(ゲートシティ大崎イーストタワー)  
 営業統括部 (03)5435-7152 関西支社 半導体営業部 (06)6455-6467  
 中部支社 半導体営業部 (052)234-4482 九州支社 半導体営業部 (092)731-7132  
 URL <http://www.fujielectric.co.jp/denshi/scd>

- Features
  - High speed switching
  - Low on-resistance
  - No secondary breakdown
  - Low driving power
  - Avalanche-proof

- Applications
  - Switching regulators
  - UPS (Uninterruptible Power Supply)
  - DC-DC converters

■ Maximum ratings and characteristic Absolute maximum ratings  
 ● (Tc=25°C unless otherwise specified)

Item	Symbol	Rated	Unit
Drain-source voltage	V <sub>DS</sub>	500	V
Continuous drain current	I <sub>D</sub>	±8	A
Pulsed drain current	I <sub>D(puls)</sub>	±32	A
Gate-source voltage	V <sub>GS</sub>	±30	V
Repetitive or non-repetitive	I <sub>AR</sub> *2	8	A
Maximum Avalanche Energy	E <sub>AS</sub> *1	173	mJ
Maximum Drain-Source dV/dt	dV <sub>DS</sub> /dt *4	20	kV/μs
Peak Diode Recovery dV/dt	dV/dt *3	5	kV/μs
Max. power dissipation	P <sub>D</sub>	T <sub>a</sub> =25°C	2.16
		T <sub>c</sub> =25°C	35
Operating and storage temperature range	T <sub>ch</sub>	+150	°C
	T <sub>stg</sub>	-55 to +150	°C

\*1 L=4.98mH, V<sub>CC</sub>=50V \*2 T<sub>ch</sub>≤150°C \*3 I<sub>F</sub>≤-I<sub>D</sub>, -di/dt=50A/μs, V<sub>CC</sub>≤BV<sub>DSS</sub>, T<sub>ch</sub>≤150°C  
 \*4 V<sub>DS</sub>≤500V

● Electrical characteristics (Tc =25°C unless otherwise specified)

Item	Symbol	Test Conditions	Min.	Typ.	Max.	Units
Drain-source breakdown voltage	V <sub>(BR)DSS</sub>	I <sub>D</sub> =250μA V <sub>GS</sub> =0V	500			V
Gate threshold voltage	V <sub>GS(th)</sub>	I <sub>D</sub> =250μA V <sub>DS</sub> =V <sub>GS</sub>	3.0		5.0	V
Zero gate voltage drain current	I <sub>DSS</sub>	V <sub>DS</sub> =500V V <sub>GS</sub> =0V	T <sub>ch</sub> =25°C		25	μA
			T <sub>ch</sub> =125°C		250	
Gate-source leakage current	I <sub>GSS</sub>	V <sub>GS</sub> =±30V V <sub>DS</sub> =0V		10	100	nA
Drain-source on-state resistance	R <sub>DS(on)</sub>	I <sub>D</sub> =4A V <sub>GS</sub> =10V		0.65	0.85	Ω
Forward transconductance	g <sub>fs</sub>	I <sub>D</sub> =4A V <sub>DS</sub> =25V	3.5	7		S
Input capacitance	C <sub>iss</sub>	V <sub>DS</sub> =25V		750	1130	pF
Output capacitance	C <sub>oss</sub>	V <sub>GS</sub> =0V		100	150	
Reverse transfer capacitance	C <sub>rss</sub>	f=1MHz		4.0	6.0	ns
Turn-on time t <sub>on</sub>	td(on)	V <sub>CC</sub> =300V I <sub>D</sub> =4A		14	21	
	tr	V <sub>GS</sub> =10V		9	14	
Turn-off time t <sub>off</sub>	td(off)	R <sub>GS</sub> =10 Ω		24	36	
	tf			6	9	
Total Gate Charge	Q <sub>G</sub>	V <sub>CC</sub> =250V		20	30	nC
Gate-Source Charge	Q <sub>GS</sub>	I <sub>D</sub> =8A		8.5	13	
Gate-Drain Charge	Q <sub>GD</sub>	V <sub>GS</sub> =10V		5.5	8.5	
Avalanche capability	I <sub>AV</sub>	L=4.98mH T <sub>ch</sub> =25°C	8			A
Diode forward on-voltage	V <sub>SD</sub>	I <sub>F</sub> =8A V <sub>GS</sub> =0V T <sub>ch</sub> =25°C		1.00	1.50	V
Reverse recovery time	t <sub>rr</sub>	I <sub>F</sub> =8A V <sub>GS</sub> =0V		0.65		μs
Reverse recovery charge	Q <sub>rr</sub>	-di/dt=100A/μs T <sub>ch</sub> =25°C		3.5		μC

● Thermal characteristics

Item	Symbol	Test Conditions	Min.	Typ.	Max.	Units
Thermal resistance	R <sub>th(ch-c)</sub>	channel to case			3.57	°C/W
	R <sub>th(ch-a)</sub>	channel to ambient			58.0	°C/W

■ Outline Drawings

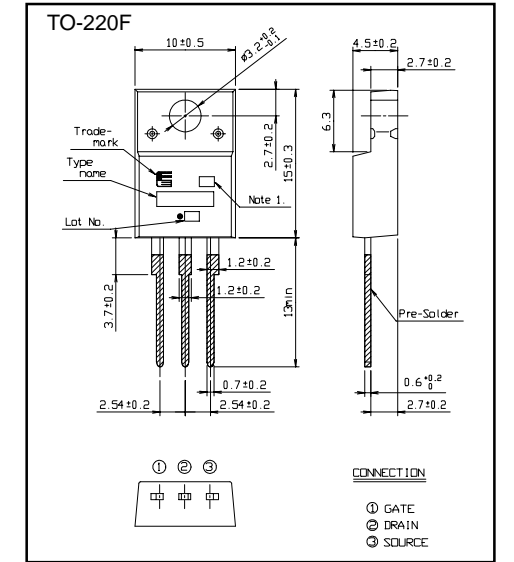

■ Equivalent circuit schematic

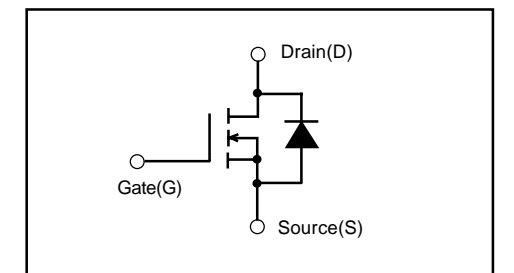

Characteristics

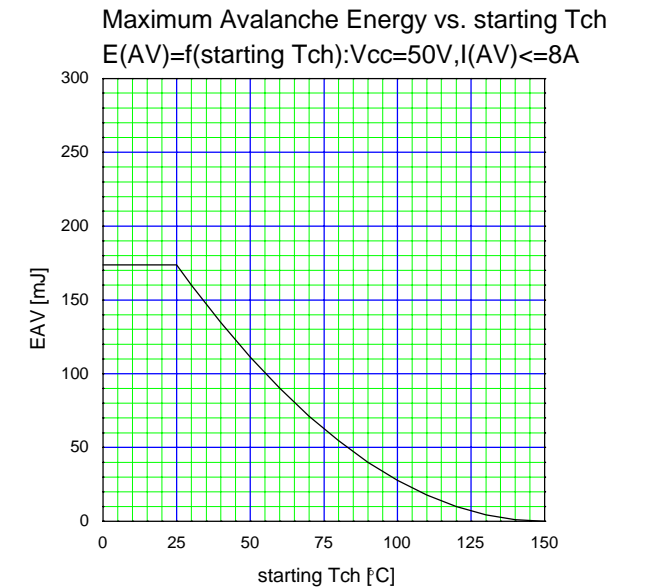
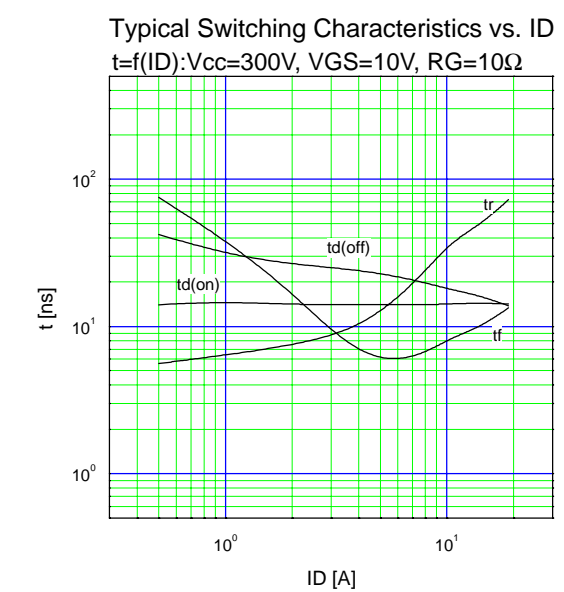
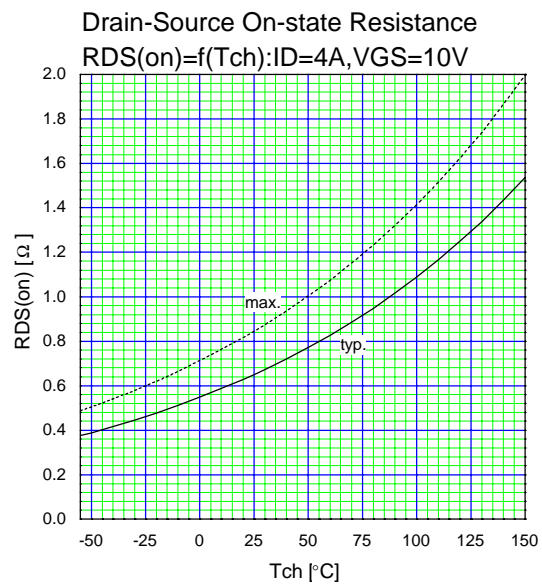
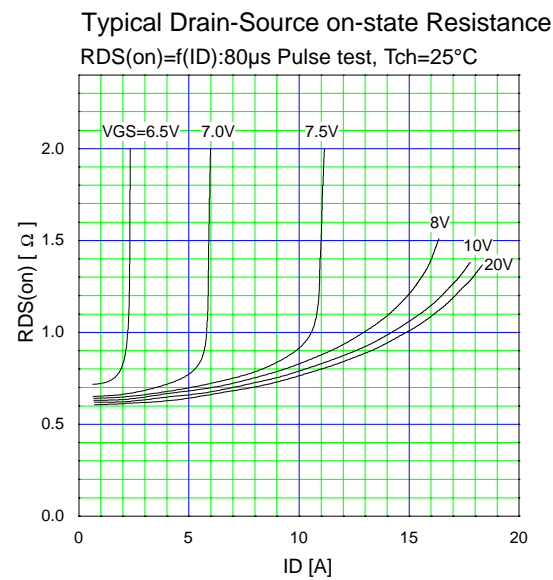
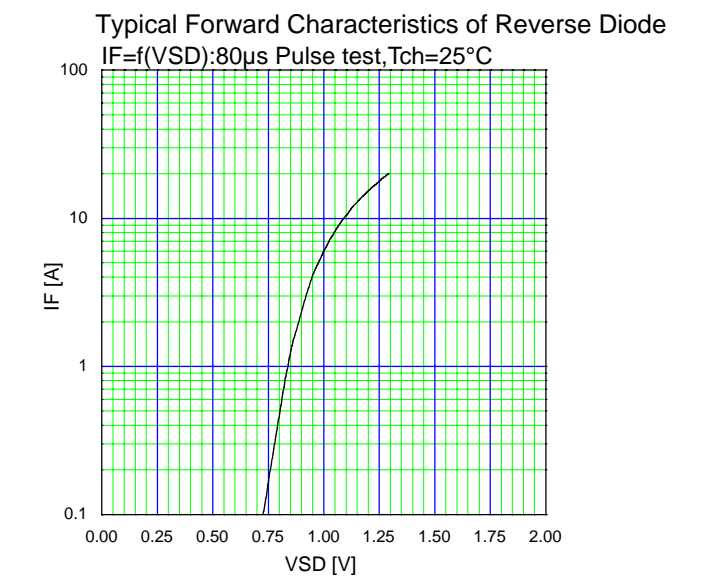
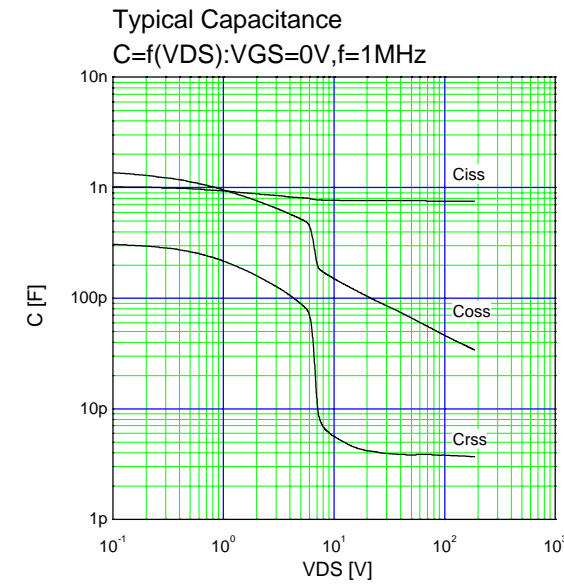
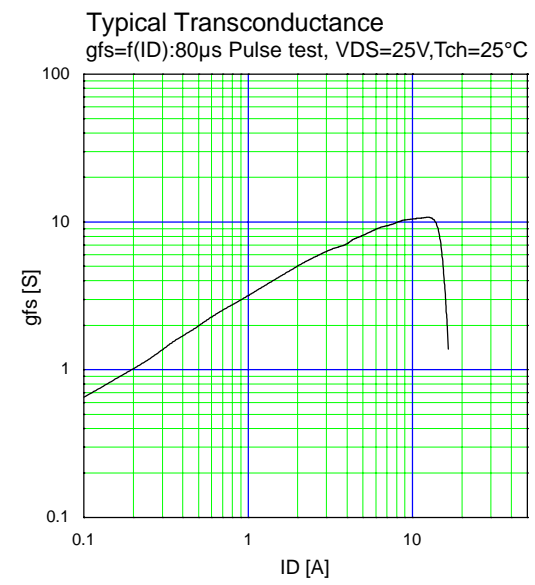
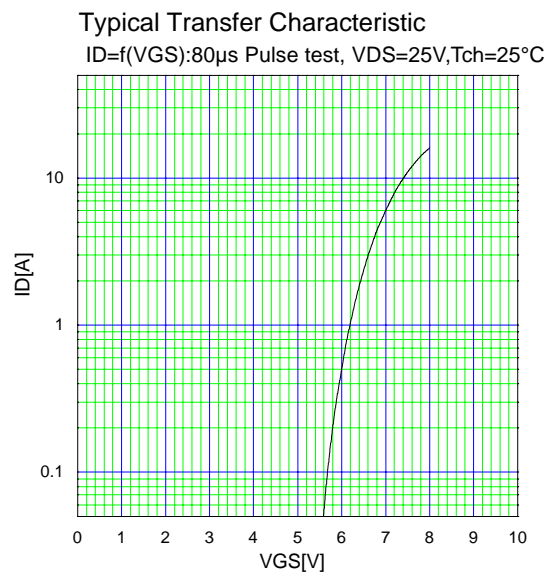
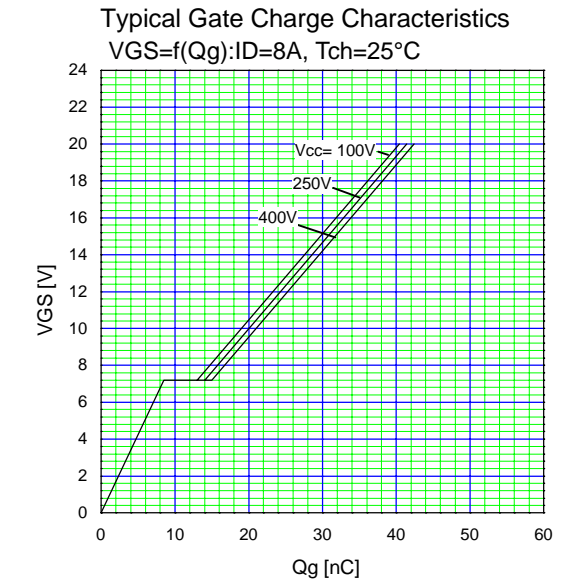
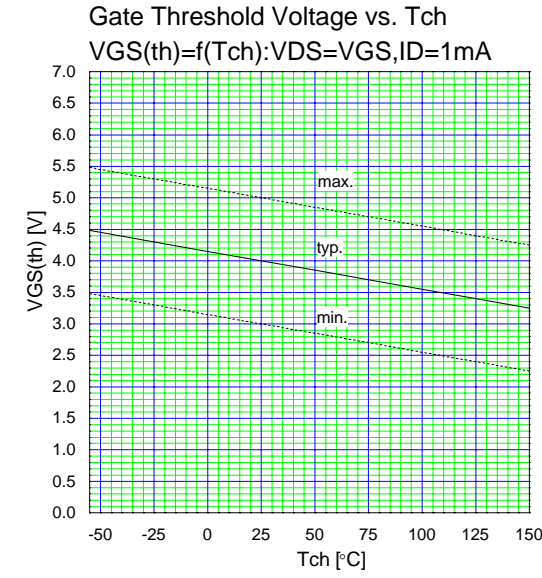
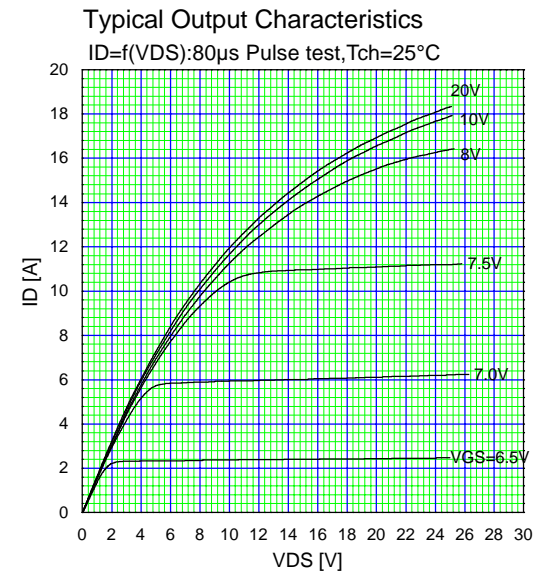
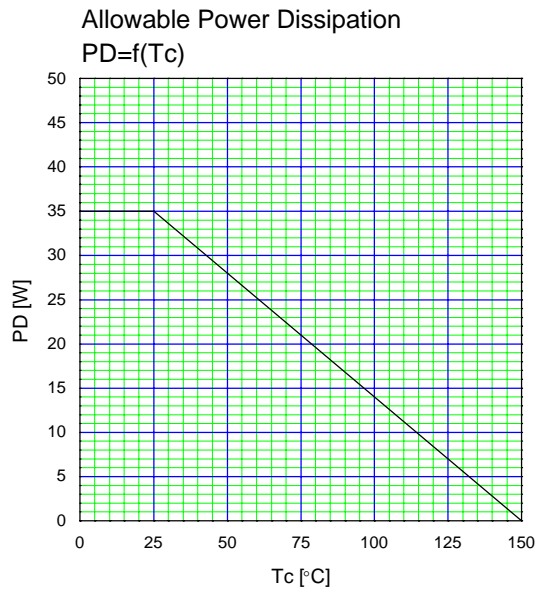

This datasheet has been downloaded from:

[www.DatasheetCatalog.com](http://www.DatasheetCatalog.com)

Datasheets for electronic components.