

# SKiiP 12AC126V1

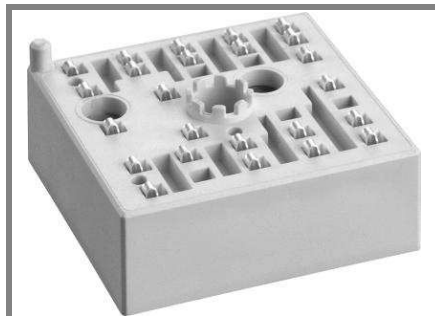

MiniSKiiP® 1

## 3-phase bridge inverter

### SKiiP 12AC126V1

#### Features

- Fast Trench IGBTs
- Robust and soft freewheeling diodes in CAL technology
- Highly reliable spring contacts for electrical connections
- UL recognised file no. E63532

#### Typical Applications\*

- Inverter up to 10 kVA
- Typical motor power 5.5 kW

#### Remarks

- $V_{CEsat}$ ,  $V_F$  = chip level value

Absolute Maximum Ratings		$T_s = 25\text{ °C}$ , unless otherwise specified	
Symbol	Conditions	Values	Units
<b>IGBT - Inverter</b>			
$V_{CES}$	$T_s = 25\text{ (70) °C}$ $t_p \leq 1\text{ ms}$	1200	V
$I_C$		28 (22)	A
$I_{CRM}$		30	A
$V_{GES}$		$\pm 20$	V
$T_j$		- 40 ... + 150	°C
<b>Diode - Inverter</b>			
$I_F$	$T_s = 25\text{ (70) °C}$ $t_p \leq 1\text{ ms}$	26 (20)	A
$I_{FRM}$		30	A
$T_j$		- 40 ... + 150	°C
$I_{tRMS}$	per power terminal (20 A / spring)	40	A
$T_{stg}$	$T_{op} \leq T_{stg}$	- 40 ... + 125	°C
$V_{isol}$	AC, 1 min.	2500	V

Characteristics		$T_s = 25\text{ °C}$ , unless otherwise specified			
Symbol	Conditions	min.	typ.	max.	Units
<b>IGBT - Inverter</b>					
$V_{CEsat}$	$I_{Cnom} = 15\text{ A}$ , $T_j = 25\text{ (125) °C}$		1,7 (2)	2,1 (2,4)	V
$V_{GE(th)}$	$V_{GE} = V_{CE}$ , $I_C = 0,6\text{ mA}$	5	5,8	6,5	V
$V_{CE(TO)}$	$T_j = 25\text{ (125) °C}$		1 (0,9)	1,2 (1,1)	V
$r_T$	$T_j = 25\text{ (125) °C}$		47 (73)	60 (87)	mΩ
$C_{ies}$	$V_{CE} = 25\text{ V}$ , $V_{GE} = 0\text{ V}$ , $f = 1\text{ MHz}$		1		nF
$C_{oes}$	$V_{CE} = 25\text{ V}$ , $V_{GE} = 0\text{ V}$ , $f = 1\text{ MHz}$		0,1		nF
$C_{res}$	$V_{CE} = 25\text{ V}$ , $V_{GE} = 0\text{ V}$ , $f = 1\text{ MHz}$		0,1		nF
$R_{th(j-s)}$	per IGBT		1,15		K/W
$t_{d(on)}$	under following conditions		25		ns
$t_r$	$V_{CC} = 600\text{ V}$ , $V_{GE} = \pm 15\text{ V}$		20		ns
$t_{d(off)}$	$I_{Cnom} = 15\text{ A}$ , $T_j = 125\text{ °C}$		375		ns
$t_f$	$R_{Gon} = R_{Goff} = 30\text{ Ω}$		90		ns
$E_{on}$	inductive load		1,7		mJ
$E_{off}$			1,9		mJ
<b>Diode - Inverter</b>					
$V_F = V_{EC}$	$I_{Fnom} = 15\text{ A}$ , $T_j = 25\text{ (125) °C}$		1,6 (1,6)	1,8 (1,8)	V
$V_{(TO)}$	$T_j = 25\text{ (125) °C}$		1 (0,8)	1,1 (0,9)	V
$r_T$	$T_j = 25\text{ (125) °C}$		40 (53)	47 (60)	mΩ
$R_{th(j-s)}$	per diode		1,95		K/W
$I_{RRM}$	under following conditions		25		A
$Q_{rr}$	$I_{Fnom} = 15\text{ A}$ , $V_R = 600\text{ V}$		3		μC
$E_{rr}$	$V_{GE} = 0\text{ V}$ , $T_j = 125\text{ °C}$ $di_F/dt = 900\text{ A/μs}$		1,2		mJ
<b>Temperature Sensor</b>					
$R_{ts}$	3 %, $T_r = 25\text{ (100) °C}$		1000(1670)		Ω
<b>Mechanical Data</b>					
m			35		g
$M_s$	Mounting torque	2		2,5	Nm

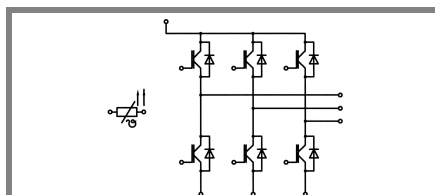

AC

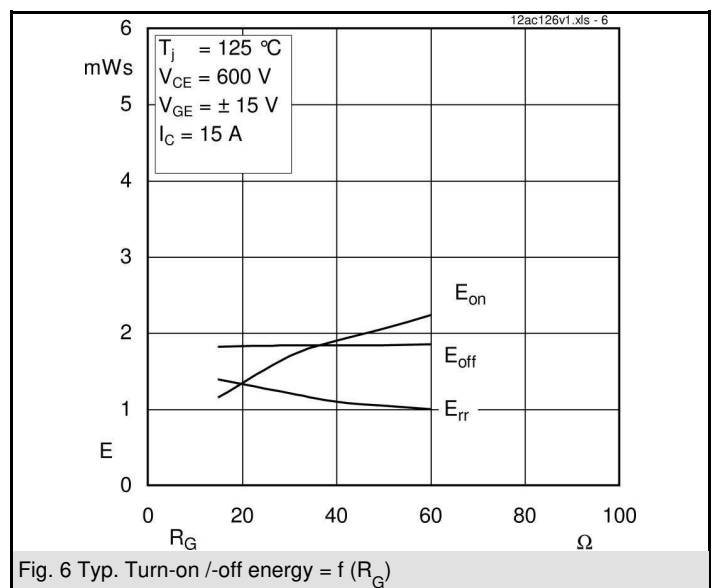
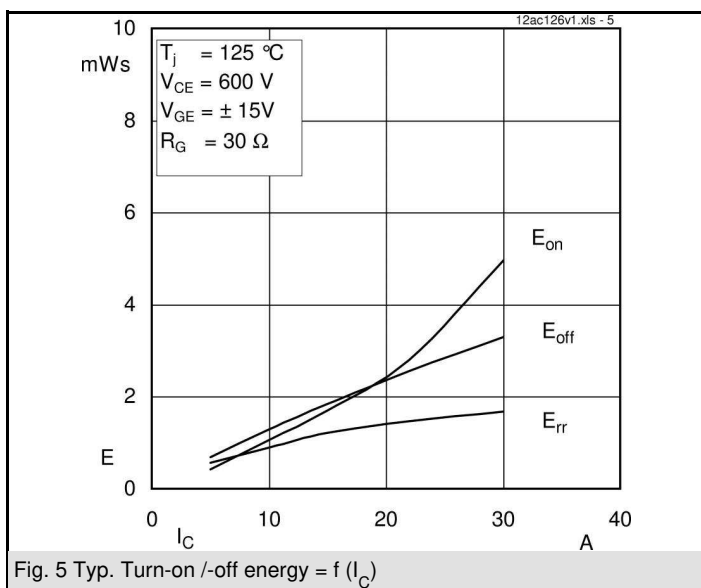
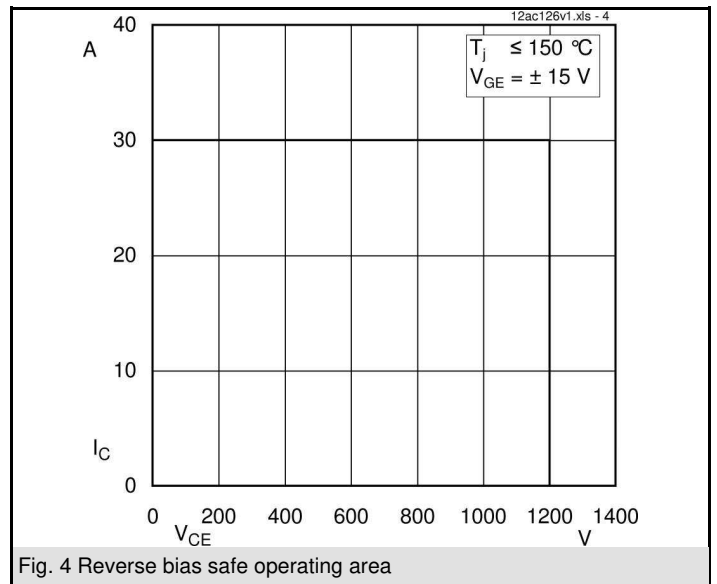
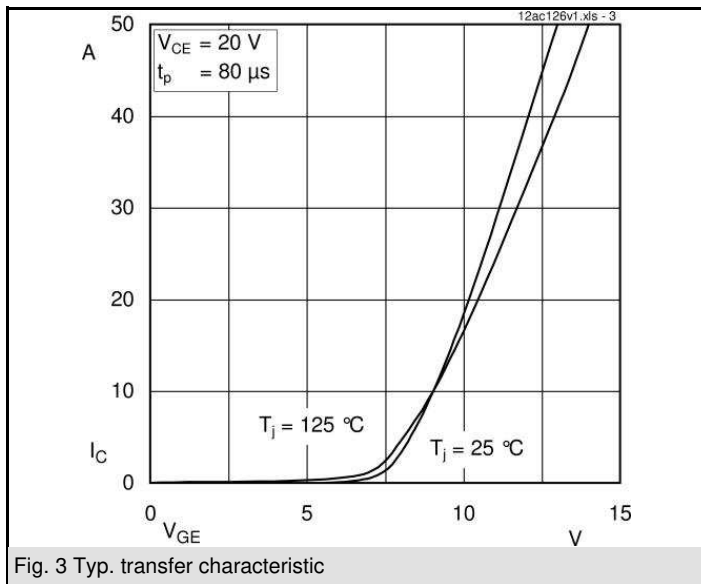
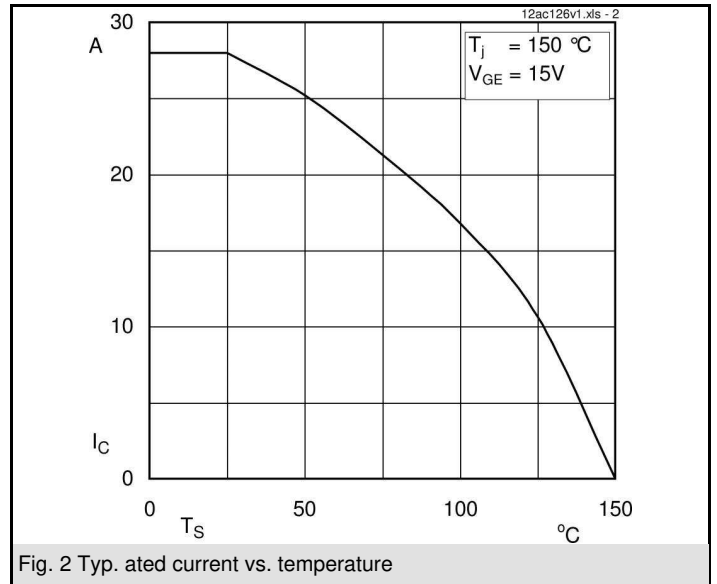
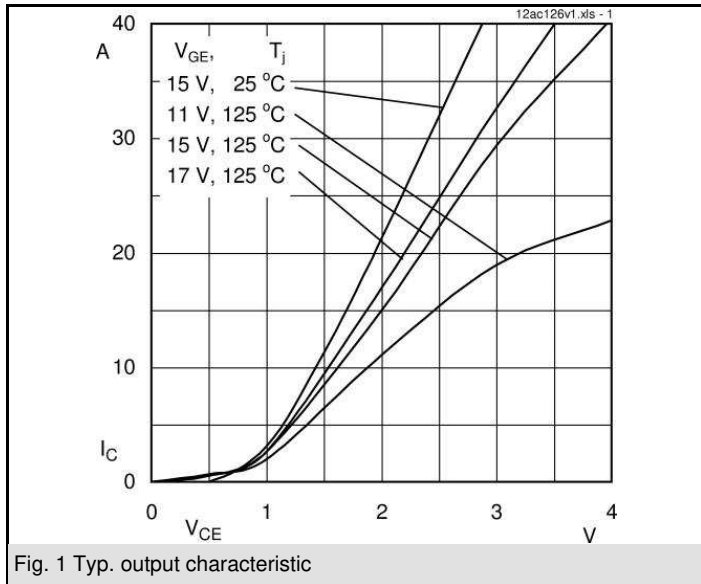

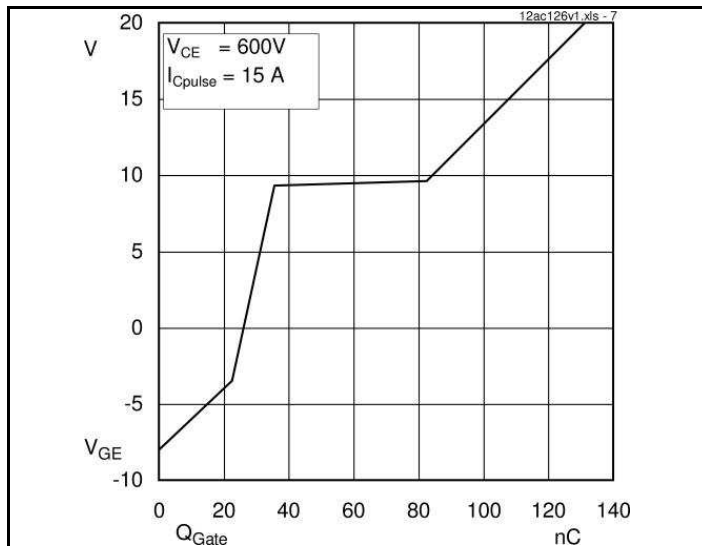

Fig. 7 Typ. gate charge characteristic

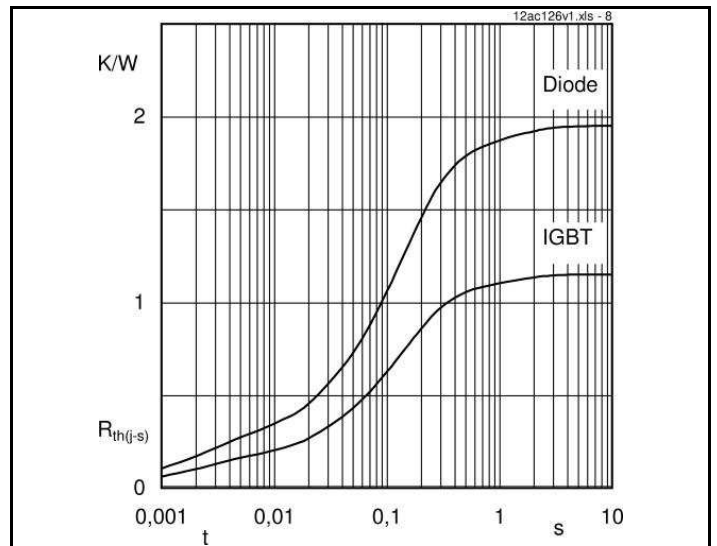

Fig. 8 Typ. thermal impedance

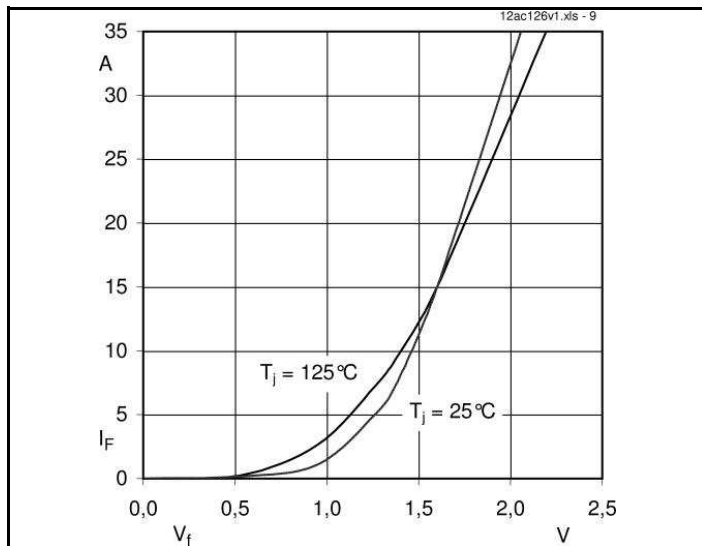
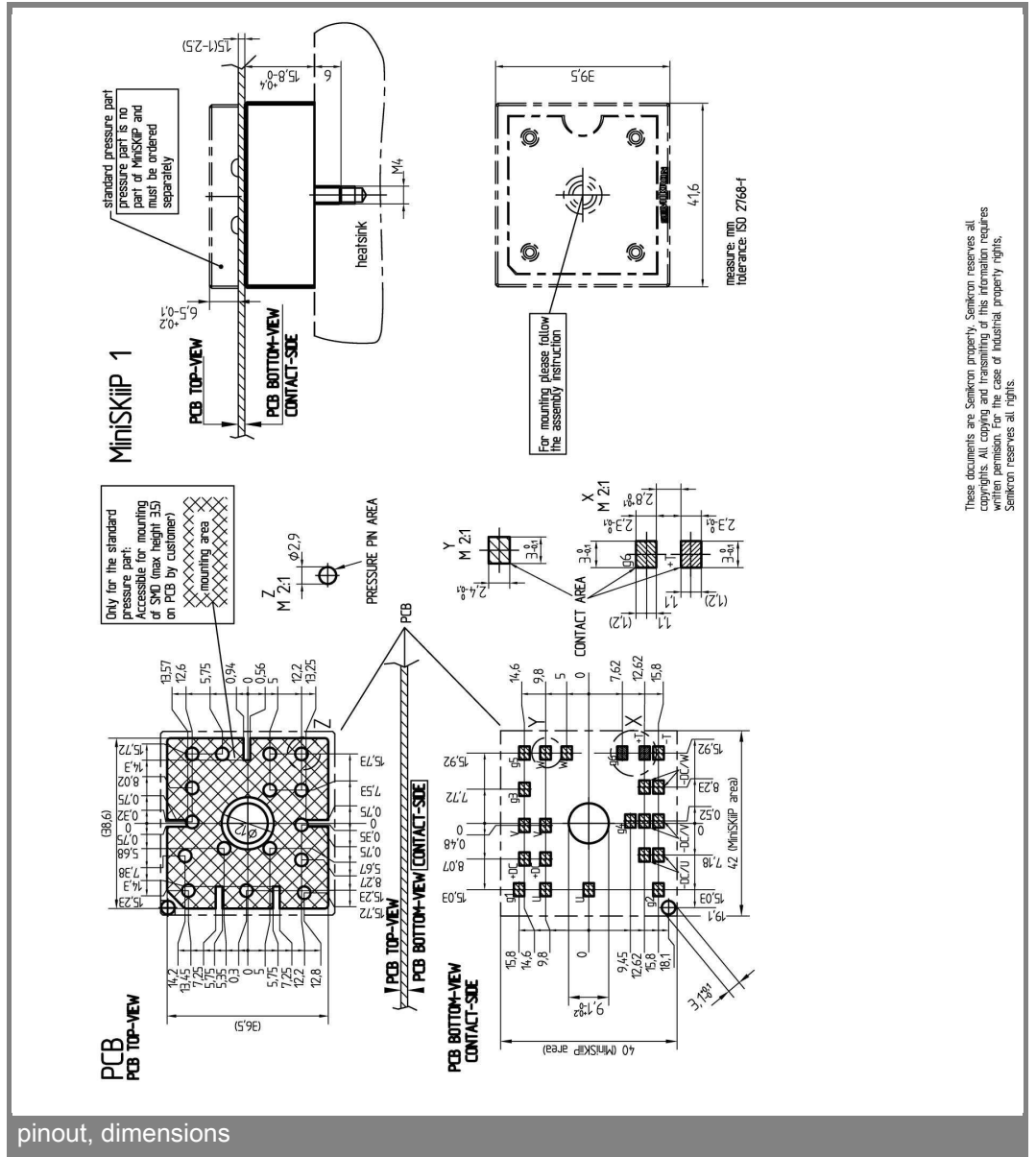
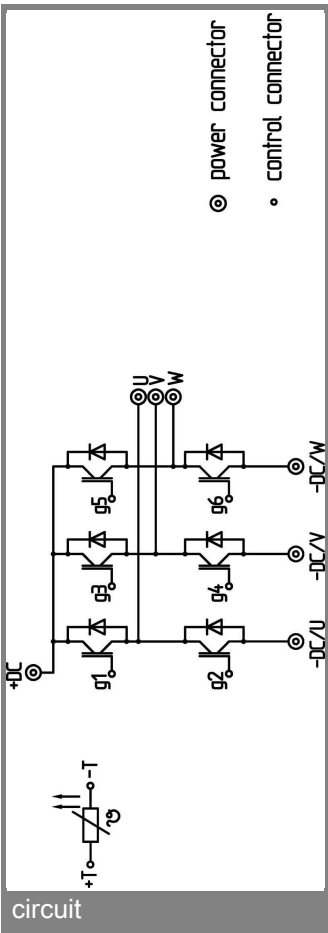

Fig. 9 Typ. freewheeling diode forward characteristic



These documents are Semikron property. Semikron reserves all copyrights. All copying and transmitting of this information requires written permission. For the case of industrial property rights, Semikron reserves all rights.

This is an electrostatic discharge sensitive device (ESDS), international standard IEC 60747-1, Chapter IX.

\* The specifications of our components may not be considered as an assurance of component characteristics. Components have to be tested for the respective application. Adjustments may be necessary. The use of SEMIKRON products in life support appliances and systems is subject to prior specification and written approval by SEMIKRON. We therefore strongly recommend prior consultation of our personal.