

AC-PG-USBASP USBASP AVR Programmer

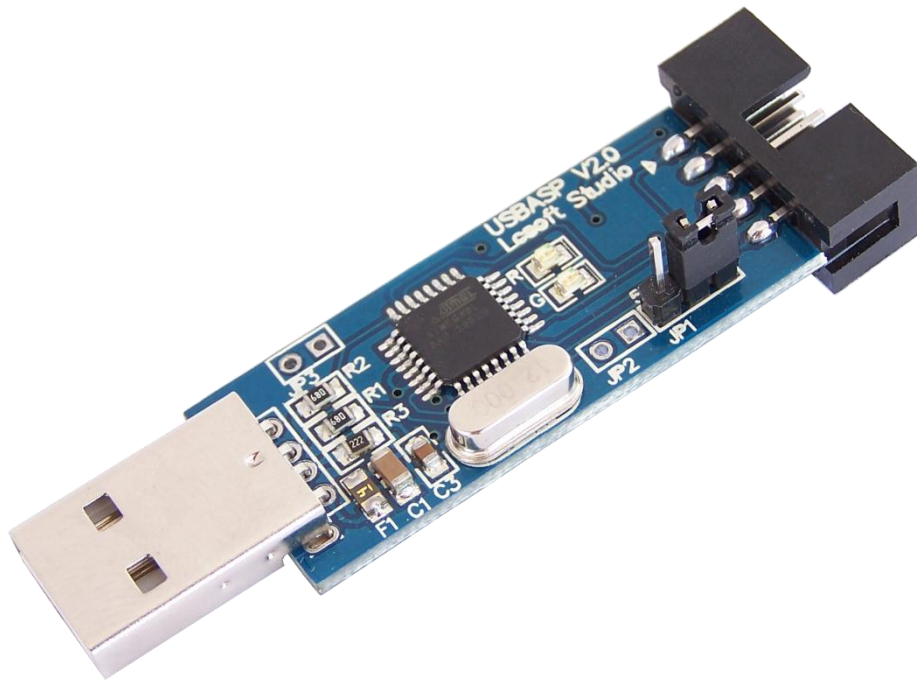

User Guide

Version 2.0
18 January 2012

AC-PG-USBASP-UG

TABLE OF CONTENTS

1. OVERVIEW	1
1.1. Introduction	1
1.2. References	1
1.2.1. Referenced Web Pages	1
1.2.2. Acronyms and Abbreviations	1
1.3. Supported Microcontrollers	2
1.4. Warnings.....	3
2. LAYOUT.....	4
2.1. USB Type A.....	4
2.2. ISP – 10 pin IDC	4
2.3. JP1 – Supply Target	5
2.4. JP2 – Self Program.....	5
2.5. JP3 – Slow SCK	5
2.6. LEDs.....	5
3. CIRCUIT DIAGRAM	6
4. USING THE PROGRAMMER.....	7
4.1. Connecting the programmer to your computer	7
4.1.1. Windows 7 (32 and 64 Bit)	7
4.1.2. Windows Vista (32 Bit).....	10
4.1.3. Windows XP (32 bit)	13
4.1.4. Other operating systems	16
4.2. Downloading firmware to your microcontroller	17
4.2.1. Required Items.....	17
4.2.2. Assumptions	17
4.2.3. Procedure	17
4.2.4. More information	18
4.3. Upgrading your USBasp	18
4.3.1. Required Items.....	18
4.3.2. Assumptions	19
4.3.3. Procedure	19
5. COMMENT AND QUESTIONS.....	20

TABLE OF TABLES

Table 1. Referenced Documents	1
Table 2. Acronyms and Abbreviations	2
Table 3. Supported Microcontrollers	3

TABLE OF FIGURES

Figure 1. Device Layout	4
Figure 2. 10 Pin ISP pinout	4
Figure 3. LEDs	5
Figure 4. Circuit Diagram	6
Figure 5. Driver Installation on Windows 7 – System Tray Message	8
Figure 6. Driver Installation on Windows 7 – Installing Device Driver Software	8
Figure 7. Driver Installation on Windows 7 – No Driver found	8
Figure 8. Driver Installation on Windows 7 – Device Manager	9
Figure 9. Driver Installation on Windows 7 – Update Driver Software	9
Figure 10. Driver Installation on Windows 7 – Browse for Driver Software	10
Figure 11. Driver Installation on Windows 7 – Confirmation	10
Figure 12. Driver Installation on Vista 32 bit – Found new hardware	11
Figure 13. Driver Installation on Vista 32 bit - Found New Hardware – USBasp	12
Figure 14. Driver Installation on Vista 32 bit – Windows couldn't find driver software for your device.	12
Figure 15. Driver Installation on Vista 32 bit – Browse for driver software	13
Figure 16. Installation on Vista 32 bit – Confirmation	13
Figure 17. Installation on Windows XP – New Hardware Wizard	14
Figure 18. Installation on Windows XP – Insert CD or install from specific location.....	15
Figure 19. Installation on Windows XP – Specify Location.....	15
Figure 20. Installation on Windows XP – Driver installation	16
Figure 21. Installation on Windows XP – Installation Confirmation	16
Figure 22. AVRdude writing a flash image to the microcontroller	18

1. Overview

1.1. Introduction

USBasp is a USB in-circuit programmer for Atmel AVR controllers. It simply consists of an ATmega8 and a few passive components. The programmer uses a firmware-only USB driver, no special USB controller is needed.

Some of the key features include:

- a. Works under multiple platforms. Linux, Mac OS X and Windows are tested,
- b. Programming speed is up to 5kBytes/sec, and
- c. Slow SCK option to support targets with low clock speed (< 1.5MHz).

1.2. References

1.2.1. Referenced Web Pages

The web pages referenced in this User Guide are listed in Table 1.

Name	Address
USBasp - USB programmer for Atmel AVR controllers	http://www.fischl.de/usbasp/
AVRdude	http://savannah.nongnu.org/projects/avrdude/
AVRdude Documentation	http://www.nongnu.org/avrdude/user-manual/avrdude.html
V-USB	http://www.obdev.at/products/vusb/index.html
WinAVR	http://winavr.sourceforge.net/
CrossPack for AVR® Development	http://www.obdev.at/products/crosspack/index.html

Table 1. Referenced Documents

1.2.2. Acronyms and Abbreviations

The acronyms and abbreviations utilised in this User Guide are listed in Table 2.

Acronym and Abbreviation	Description
AVR	According to Atmel, AVR stands for nothing, it's just a name. Others say it stands for Advanced Virtual RISC. However, the inventors of the AVR series chips are named Alf Egil Bogen and Vegard Wollan, so you be the judge.
IDC	Insulation Displacement Connector
ISP	In System Programmer
LED	Light Emitting Diode
RISC	Reduced Instruction Set Computing
SCK	Serial Clock
SIL	Single in Line
SPI	Serial Peripheral Interface
USB	Universal Serial Bus

Table 2. Acronyms and Abbreviations

1.3. Supported Microcontrollers

Table 3 lists the microcontrollers that are supported by the USB AVR Programmer.

Supported Microcontrollers				
Mega Series				
ATmega8	ATmega8A	ATmega48	ATmega48A	ATmega48P
ATmega48PA	ATmega88	ATmega88A	ATmega88P	ATmega88PA
ATmega168	ATmega168A	ATmega168P	ATmega168PA	ATmega328
ATmega328P	ATmega103	ATmega128	ATmega128P	ATmega1280
ATmega1281	ATmega16	ATmega16A	ATmega161	ATmega162
ATmega163	ATmega164	ATmega164A	ATmega164P	ATmega164PA
ATmega169	ATmega169A	ATmega169P	ATmega169PA	ATmega2560
ATmega2561	ATmega32	ATmega32A	ATmega324	ATmega324A
ATmega324P	ATmega324PA	ATmega329	ATmega329A	ATmega329P
ATmega329PA	ATmega3290	ATmega3290A	ATmega3290P	ATmega64
ATmega64A	ATmega640	ATmega644	ATmega644A	ATmega644P
ATmega644PA	ATmega649	ATmega649A	ATmega649P	ATmega6490
ATmega6490A	ATmega6490P	ATmega8515	ATmega8535	
Tiny Series				
ATtiny12	ATtiny13	ATtiny13A	ATtiny15	ATtiny25
ATtiny26	ATtiny45	ATtiny85	ATtiny2313	ATtiny2313A
Classic Series				
AT90S1200	AT90S2313	AT90S2333	AT90S2343	AT90S4414
AT90S4433	AT90S4434	AT90S8515		
AT90S8535				
Can Series				
AT90CAN128				
PWN Series				
AT90PWM2	AT90PWM3			

Table 3. Supported Microcontrollers

1.4. Warnings



Some of the components discussed in this document are very sensitive to electrical static discharges. The reader should take precautions to ensure that components are protected against these discharges.



Whilst the voltages typically seen in microcontroller circuits are low, the reader should be aware of the risk of working with electrical circuits and take necessary precautions.

2. Layout

The layout of the USBASP programmer is shown in Figure 1.

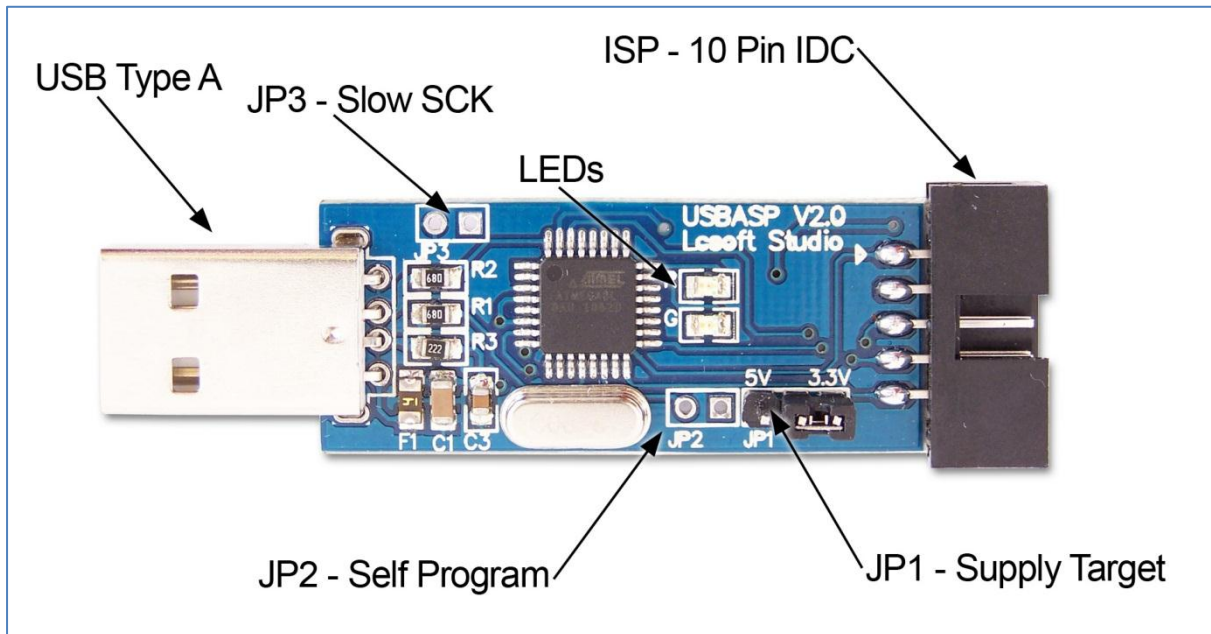

Figure 1. Device Layout

2.1. USB Type A

The USB end of the programmer connects directly into your computers USB port.

2.2. ISP – 10 pin IDC

The 10 pin ISP connection provides an interface to the microcontroller. This interface uses a 10 pin IDC connector and the pinout is shown in Figure 2

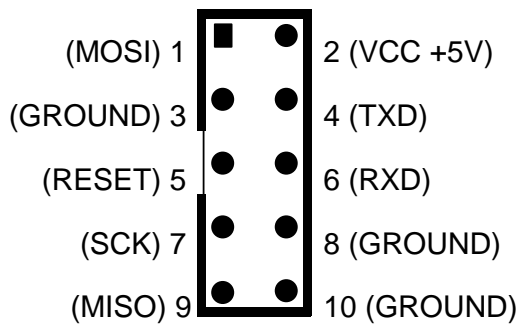

Figure 2. 10 Pin ISP pinout

2.3. JP1 – Supply Target

This jumper controls the voltage on the ISP VCC connector. It can be set to +3.3V, +5V or disable this jumper if the target device has its own power source.

2.4. JP2 – Self Program

This jumper is used to update the firmware of the USBasp programmer. In order to update the firmware you will need 2 programmers. One to be programmed and the other to do the programming.

2.5. JP3 – Slow SCK

When this jumper is selected, the slow clock mode is enabled. If the target clock is lower than 1.5 MHz, you need to set this jumper. Then SCK is scaled down from 375 kHz to about 8 kHz.

2.6. LEDs

The USBASP programmer has 2 LEDs near the ISP connection. These have the following functions:

- a. LED R – Programmer communicating with target device
- b. LED G – Power

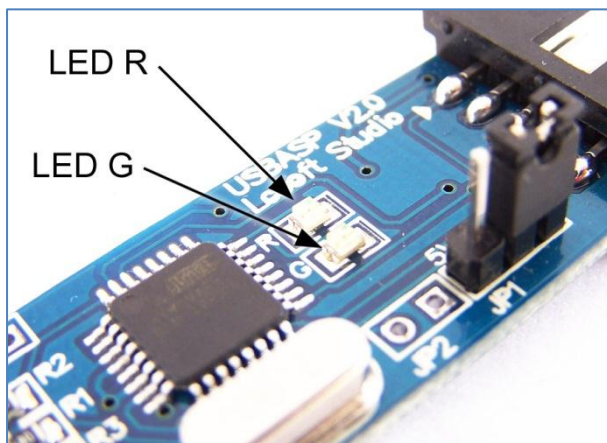

Figure 3. LEDs

Whilst you might assume that LED R is red and LED G is green, they do vary depending on the batch. The one I use for instance has 2 red LEDs.

3. Circuit Diagram

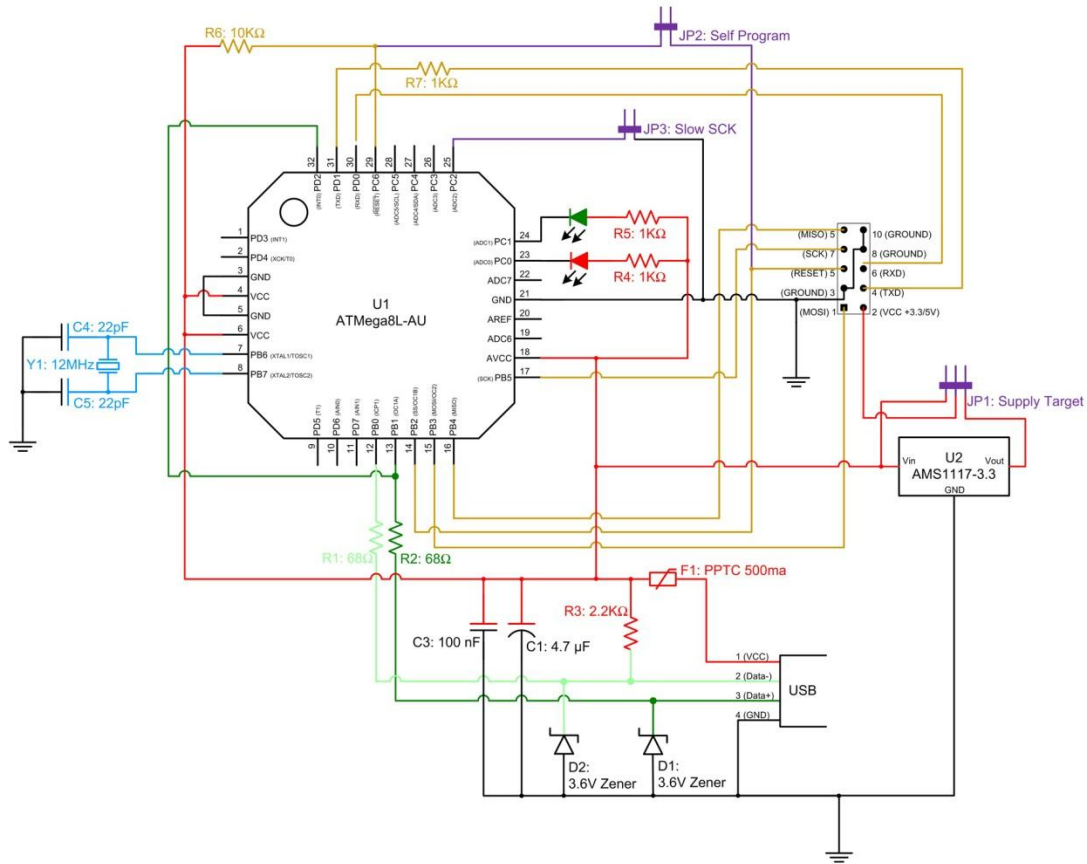

Figure 4. Circuit Diagram

4. Using the Programmer

4.1. Connecting the programmer to your computer

Connecting the programmer to your computer comprises of 2 steps:

- a. Physically connecting the programmer to the USB port, and
- b. Installing drivers in order for it to work.

Whilst the USBasp programmer will work on a wide variety of operating systems, this procedure will focus on Windows Vista 32 bit and Windows XPs

4.1.1. Windows 7 (32 and 64 Bit)

4.1.1.1. Required items

Items required to run this procedure are:

- a. USBasp programmer
- b. Computer with USB port and Windows 7 installed
- c. USBasp drivers downloaded and unzipped from
 - (1) <http://www.protostack.com/download/USBasp-win-driver-x86-x64-ia64-v1.2.5.zip> or
 - (2) <http://www.protostack.com/download/USBasp-win-driver-x86-x64-ia64-v1.2.5.rar> .
Some people have problems with the zip file so rar file is available as well

4.1.1.2. Assumptions

This procedure assumes that:

- a. The logged in user has sufficient privileges to install device drivers

4.1.1.3. Procedure

To install the USBasp programmer:

- a. Insert the programmer into an available USB port

- b. A message will appear in the system tray, as shown below. Click on “Click here for status” to see what is going on.

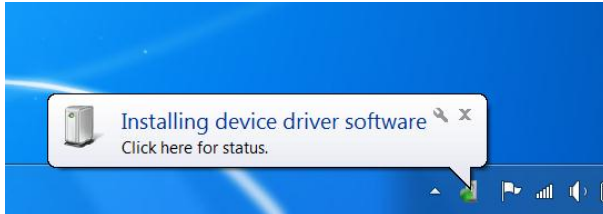

Figure 5. Driver Installation on Windows 7 – System Tray Message

- c. Windows will attempt to install a driver from Windows Update

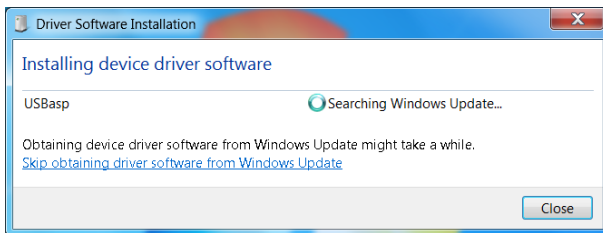

Figure 6. Driver Installation on Windows 7 – Installing Device Driver Software

- d. and will fail

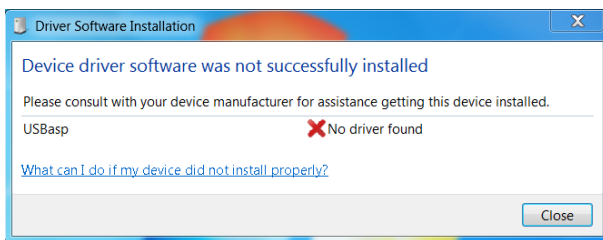

Figure 7. Driver Installation on Windows 7 – No Driver found

- e. At this point, go into device manager and find the entry for the USBASP programmer. It should be displayed with a yellow alert icon next to it.
- f. Right click on the device and select "Update Driver Software"

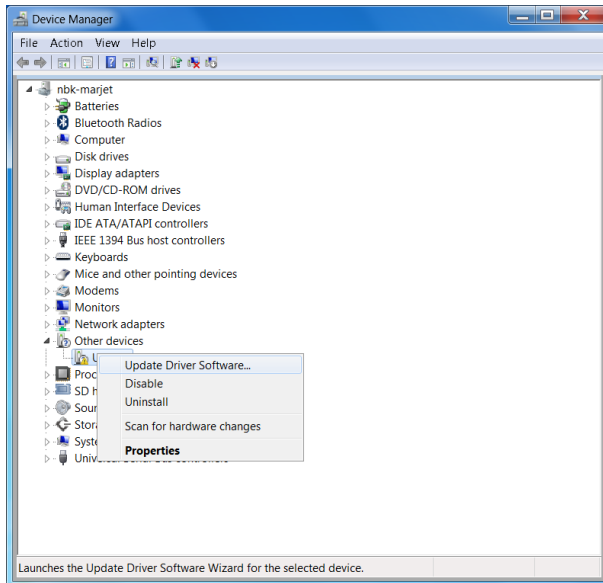

Figure 8. Driver Installation on Windows 7 – Device Manager

- g. When prompted "How do you want to search for driver software", select "Browse my computer for driver software"

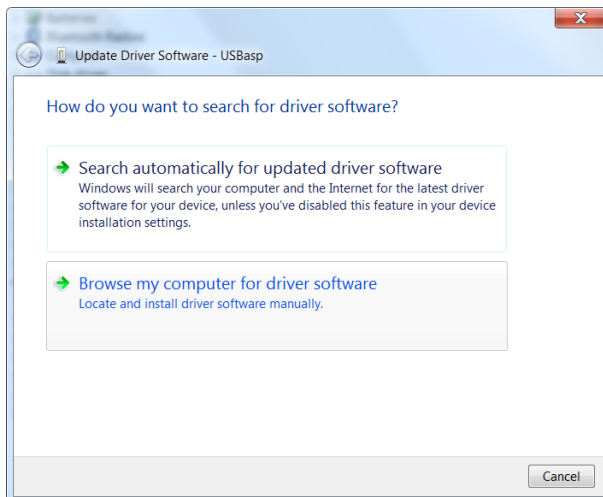

Figure 9. Driver Installation on Windows 7 – Update Driver Software

- h. Select the folder where you unzipped the driver files then click “Next”

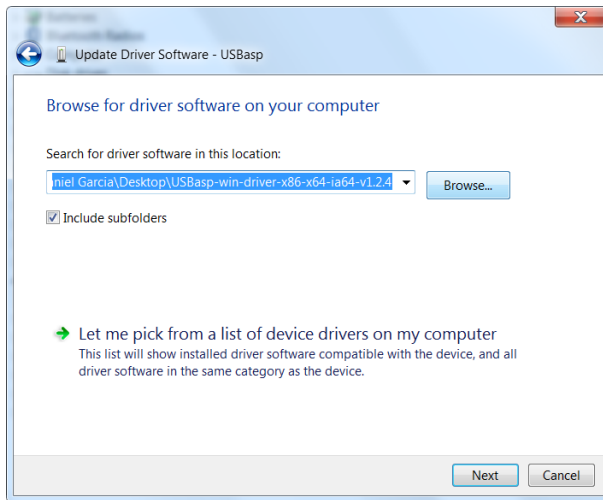

Figure 10. Driver Installation on Windows 7 – Browse for Driver Software

- i. When the installation is complete, a confirmation screen will be displayed. Click close to close it.

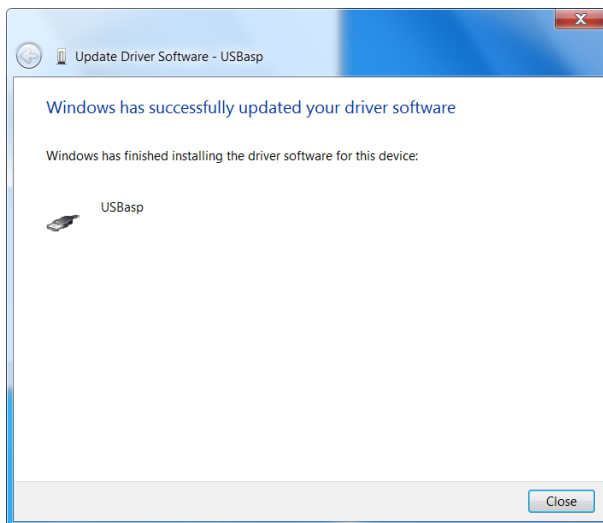

Figure 11. Driver Installation on Windows 7 – Confirmation

- j. your programmer is now ready for use.

4.1.2. Windows Vista (32 Bit)

4.1.2.1. Required items

Items required to run this procedure are:

- a. USBasp programmer
- b. Computer with USB port and Windows Vista 32 Bit installed

- c. USBasp drivers downloaded and unzipped from
 - (1) <http://www.protostack.com/download/USBasp-win-driver-x86-x64-ia64-v1.2.5.zip> or
 - (2) <http://www.protostack.com/download/USBasp-win-driver-x86-x64-ia64-v1.2.5.rar> .
Some people have problems with the zip file so rar file is available as well

4.1.2.2. Assumptions

This procedure assumes that:

- a. The logged in user has sufficient privileges to install device drivers

4.1.2.3. Procedure

To install the USBasp programmer:

- a. Insert the programmer into an available USB port
- b. When the “Found New Hardware” dialog opens, select “Locate and install driver software (recommended)”



Figure 12. Driver Installation on Vista 32 bit – Found new hardware

- c. Wait while Windows Vista attempts to locate a driver
- d. When the “Found New Hardware – USBasp” dialog box is displayed, select “I don’t have the disc. Show me other options”

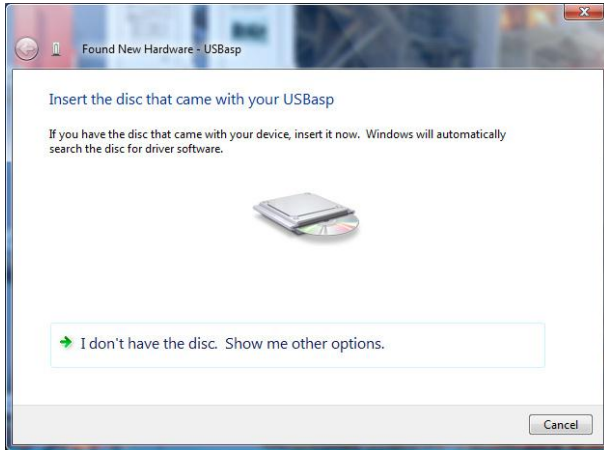

Figure 13. Driver Installation on Vista 32 bit - Found New Hardware – USBasp

- e. On the next screen select “Browse my computer for driver software (advanced)”

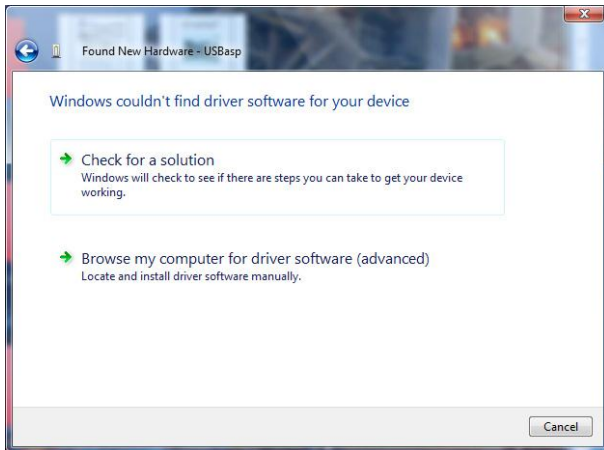

Figure 14. Driver Installation on Vista 32 bit – Windows couldn't find driver software for your device

- f. Click Browse and select the folder where you unzipped the USBasp drivers, then click Next

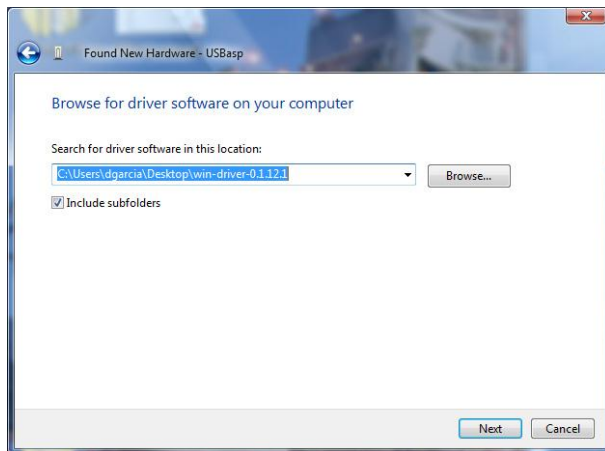

Figure 15. Driver Installation on Vista 32 bit – Browse for driver software

- g. When the installation is complete, a confirmation screen will be displayed. Click close to close it.

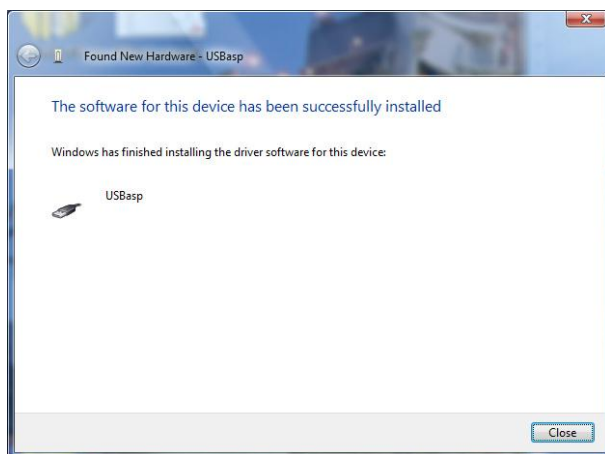

Figure 16. Installation on Vista 32 bit – Confirmation

- h. Your programmer is now ready for use

4.1.3. Windows XP (32 bit)

4.1.3.1. Required items

Items required to run this procedure are:

- a. USBasp programmer
- b. Computer with USB port and Windows XP 32 bit installed
- c. USBasp drivers downloaded and unzipped from

- (1) <http://www.protostack.com/download/USBasp-win-driver-x86-x64-ia64-v1.2.5.zip> or
- (2) <http://www.protostack.com/download/USBasp-win-driver-x86-x64-ia64-v1.2.5.rar> .
Some people have problems with the zip file so rar file is available as well

4.1.3.2. Assumptions

This procedure assumes that:

- a. The logged in user has sufficient permissions to install device drivers

4.1.3.3. Procedure

To install the USBasp programmer:

- a. Insert the programmer into an available USB port
- b. When the “New Hardware Wizard” dialog box is displayed, select “No, not this time” then click Next



Figure 17. Installation on Windows XP – New Hardware Wizard

- c. On the next page select “Install from a list of specific location (Advanced)” then click Next

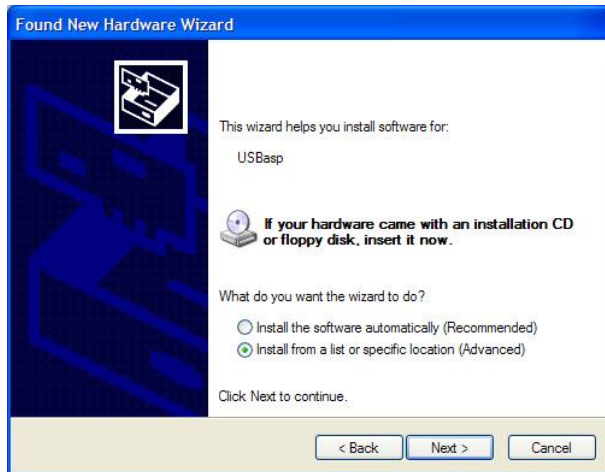

Figure 18. Installation on Windows XP – Insert CD or install from specific location

- d. On the Search and Installation options page
 - (1) Ensure that “Include this location in the search” is checked,
 - (2) Click Browse and select the folder where you unzipped the USBasp drivers, then
 - (3) Click Next



Figure 19. Installation on Windows XP – Specify Location

- e. Wait for the driver to install

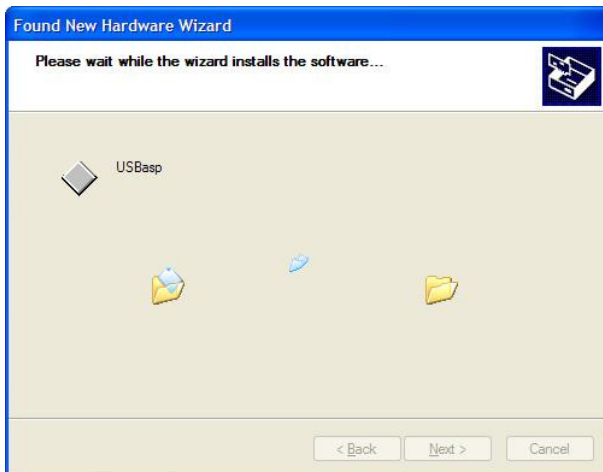

Figure 20. Installation on Windows XP – Driver installation

- f. When the installation is complete, a confirmation screen will be displayed. Click close to close it.

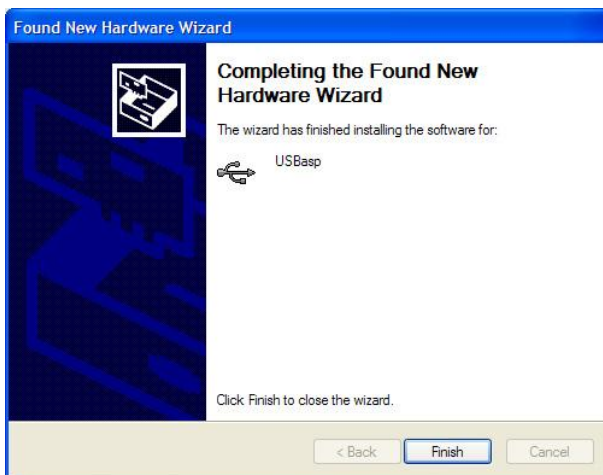

Figure 21. Installation on Windows XP – Installation Confirmation

- g. Your programmer is now ready for use

4.1.4. Other operating systems

USBasp works under other operating systems such as Mac OS X and Linux, by drivers are not provided by ProtoStack nor are installation instructions included in this user's guide.

The USBasp programmer uses the V-USB library and driver source code can be downloaded this page <http://www.obdev.at/products/vusb> and <http://libusb-win32.sourceforge.net/>.

Mac users may also want to look at <http://www.obdev.at/products/crosspack>.

4.2. Downloading firmware to your microcontroller

4.2.1. Required Items

Item required for this procedure include:

- a. USBasp programmer,
- b. Computer with USB port and AVRdude software installed,
- c. Precompiled firmware to be loaded,
- d. 10 pin ISP cable, and
- e. AVR Microcontroller with ISP interface wired to it (e.g. an AVR microcontroller on a ProtoStack 28 pin AVR board)

4.2.2. Assumptions

This procedure assumes that

- a. AVRdude is in the path, and
- b. USBasp drivers have already been installed.

4.2.3. Procedure

To download the firmware to your microcontroller:

- a. Insert the programmer into an available USB port
- b. Connect the programmer to the microcontroller via a 10 pin ISP cable (*see Required items d & e*),
- c. Open a command prompt
- d. Enter the following command where
 - (1) <FILE> is the filename of the precompiled binary file , and
 - (2) <DEVICE> is the micro controller type you are programming (eg ATMEGA8).
The full list of device codes is listed at http://www.nongnu.org/avrdude/user-manual/avrdude_4.html#Option-Descriptions

```
avrdude -p <DEVICE> -P usb -c usbasp -U flash:w:<FILE>
```

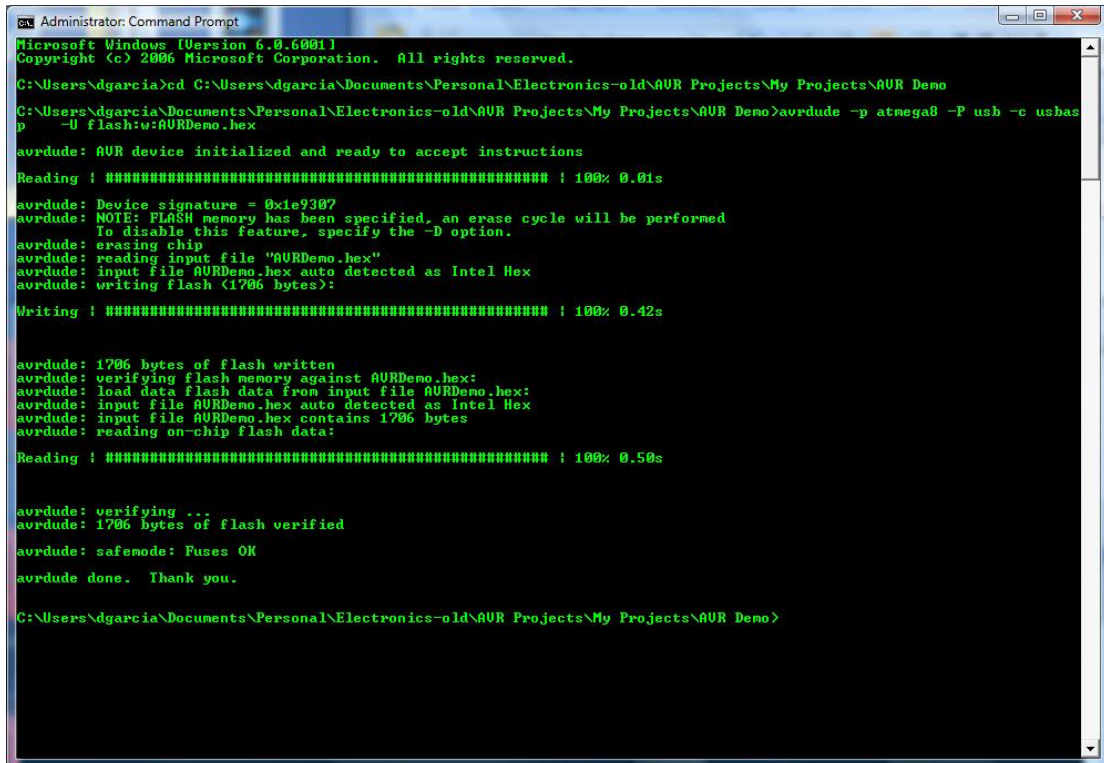

Figure 22. AVRdude writing a flash image to the microcontroller

4.2.4. More information

Please refer to the AVRdude documentation at <http://www.nongnu.org/avrdude/user-manual/avrdude.html> for more information.

4.3. Upgrading your USBasp

4.3.1. Required Items

Item required for this procedure include:

- a. USBasp programmer being programmed (referred to as target programmer)
- b. USBasp programmer doing the programming (referred to as active programmer),
- c. Computer with USB port and AVRdude software installed,
- d. Precompiled firmware to be loaded (can be downloaded from <http://www.fischl.de/usbasp/>), and
- e. 10 pin ISP cable.

4.3.2. Assumptions

This procedure assumes that

- a. The precompiled firmware filename is main.hex,
- b. AVRdude is in the path, and
- c. USBasp drivers have already been installed.

4.3.3. Procedure

To download a new copy of the firmware to a USBasp programmer:

- a. Insert the active programmer into an available USB port
- b. Set the JP2 jumper on the target programmer
If there is no header on JP2, then solder one on
- c. Connect the 10 pin ISP cable from the active to the target programmer
- d. Open a command prompt
- e. Enter the following command

```
avrdude -p atmega8 -P usb -c usbasp -U flash:w:main.hex
```

5. Comment and Questions

If you have any questions or comments regarding this documentation or any of our products, please contact us via

http://www.protostack.com/index.php?main_page=contact_us.