



e-Link32/e-Link32 Pro User's Guide

Revision: V1.30 Date: November 13, 2020

www.holtek.com

Table of Contents

| | |
|--|-----------|
| 1 Overview | 6 |
| Introduction | 6 |
| Hardware Description | 7 |
| Hardware Configuration | 7 |
| Dynamically Switching Power Configuration | 9 |
| e-Link32/e-Link32 Pro Schematic Diagram | 9 |
| 2 MDK_ARM (KEIL) Setup and Use | 13 |
| e-Link32/e-Link32 Pro for Keil Installation | 13 |
| e-Link32/e-Link32 Pro with Keil4 Setup and Use | 20 |
| e-Link32 Pro with Keil5 Setup and Use (No Support e-Link32)..... | 22 |
| 3 IAR Setup and Use | 24 |
| e-Link32/e-Link32 Pro for IAR Installation | 24 |
| e-Link32/e-Link32 Pro with IAR EWARM Setup and Use..... | 30 |

Table of Contents

List of Tables

- Table 1. SWD 10-Pin Connector Pins 7
- Table 2. Power Configuration – SWD/RESET/UART Interface Voltage determined by the Target Board Power Supply 8
- Table 3. Power Configuration – MCU with Independent IO Power Supply 8
- Table 4. Power Configuration – Target Board Power Supply Provided by e-Link32/e-Link32 Pro 8
- Table 5. Power Supply Switch – J4 9

List of Figures

| | |
|---|----|
| Figure 1. e-Link32/e-Link32 Pro Debug Adapter Appearance | 6 |
| Figure 2. SWD 10-Pin Connector | 7 |
| Figure 3. e-Link32 v1.0 (HT32F1654)..... | 10 |
| Figure 4. e-Link32 v1.0 (HT32F52341)..... | 11 |
| Figure 5. e-Link32 Pro v1.0 | 12 |
| Figure 6. HT32_Setup_Keil_vxx.exe Installation Introduction | 13 |
| Figure 7. HT32_Setup_Keil_vxx.exe Installation Path..... | 14 |
| Figure 8. HT32_Setup_Keil_vxx.exe Installation Process | 14 |
| Figure 9. Holtek e-Link32 USB Driver Installation Introduction..... | 15 |
| Figure 10. Holtek e-Link32 USB Driver Installation Path | 15 |
| Figure 11. Holtek e-Link32 USB Driver Installation Completion..... | 16 |
| Figure 12. Holtek e-Link32 Keil Plugin Old Version Uninstallation | 16 |
| Figure 13. Holtek e-Link32 Keil Plugin Installation Introduction..... | 17 |
| Figure 14. Holtek e-Link32 Keil Plugin Installation Path | 17 |
| Figure 15. Holtek HT32 Keil Support Package Installation Introduction | 18 |
| Figure 16. Holtek HT32 Keil Support Package Installation Path | 18 |
| Figure 17. Keil Installation Completion | 19 |
| Figure 18. e-Link32 Device Name | 19 |
| Figure 19. e-Link32 Pro Device Name..... | 20 |
| Figure 20. Keil4 Debugger Selection | 20 |
| Figure 21. Keil4 e-Link32 Setting Window | 21 |
| Figure 22. Keil4 e-Link32 Pro Setting Window | 21 |
| Figure 23. Keil4 - Flash Download Setup | 22 |
| Figure 24. Keil5 Debugger Selection | 22 |
| Figure 25. Keil5 Debugger Setup | 23 |
| Figure 26. Keil5 – Flash Download Setup | 23 |
| Figure 27. HT32_Setup_IAR_vxx.exe Installation Introduction | 24 |
| Figure 28. HT32_Setup_IAR_vxx.exe Installation Path..... | 25 |
| Figure 29. HT32_Setup_IAR_vxx.exe Installation Process | 25 |
| Figure 30. Holtek e-Link32 USB Driver Installation Introduction..... | 26 |
| Figure 31. Holtek e-Link32 USB Driver Installation Path | 26 |
| Figure 32. Holtek e-Link32 USB Driver Installation Completion | 27 |
| Figure 33. Holtek e-Link32 IAR Plugin Old Version Uninstallation | 27 |
| Figure 34. Holtek e-Link32 IAR Plugin Installation Introduction..... | 28 |
| Figure 35. Holtek e-Link32 IAR Plugin Installation Path | 28 |
| Figure 36. Holtek HT32 IAR Support Package Installation Introduction | 29 |
| Figure 37. e-Link32 Device Name | 29 |
| Figure 38. e-Link32 Pro Device Name..... | 30 |
| Figure 39. IAR Options | 30 |

Figure 40. IAR Debugger Selection 31

Figure 41. IAR e-Link32 Debugger Setup..... 32

Figure 42. IAR e-Link32 Pro Debugger Setup 33

Figure 43. IAR e-Link32 Debugger Function Table..... 33

Figure 44. IAR e-Link32 Pro Debugger Function Table 33

1 Overview

The purpose of this user's guide is to familiarise users with the Holtek e-Link32/e-Link32 Pro Debug Adapter. The guide includes information on how to setup and use the e-Link32/e-Link32 Pro with the Keil MDK-ARM and IAR EWARM.

Introduction

The Holtek e-Link32/e-Link32 Pro connects the target board (via Serial Wire) to the PC's USB port. Users can then program and debug their embedded programs on the target board.

The e-Link32/e-Link32 Pro provides the following key features.

- Supports HT32 Series MCUs
- Serial Wire Debug interface
- Integrates with Keil & IAR IDE
- USB powered
- 10-pin Cortex Debug Connector
- Three LEDs used to display the USB, ERROR and RUN status
- Single RESET button
- Serial communication with the target MCU (for e-Link32 Pro only)



Figure 1. e-Link32/e-Link32 Pro Debug Adapter Appearance

Hardware Description

The e-Link32/e-Link32 Pro supports a Serial Wire Mode interface. There are only two pins, SWCLK (Serial Wire Clock) and SWDIO (Serial Wire Debug Data Input/Output), which are used for programming and debugging. However there are another two USB Virtual COM Ports for the e-Link32 Pro Serial Communication ^(Note). The following illustration shows the debug connector.

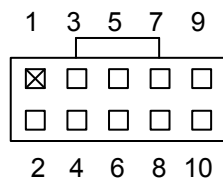

Figure 2. SWD 10-Pin Connector

Table 1. SWD 10-Pin Connector Pins

| Pin# | Description | Pin# | Description |
|------|----------------------------------|------|----------------------------------|
| 1 | 3.3V | 2 | SWDIO |
| 3 | GND | 4 | SWCLK |
| 5 | GND | 6 | Reserved |
| 7 | NC (VCOM_RXD ^(Note)) | 8 | NC (VCOM_TXD ^(Note)) |
| 9 | GND | 10 | Reset |

Note: The serial communication function is only available for the e-Link32 Pro, Pin7 and Pin8 are NC pins for the e-Link32.

Hardware Configuration

As the MCU has a wide operating voltage range, the SWD and other interface IO voltages of the MCU may be different from the e-Link32/e-Link32 Pro which both operate at 3.3V. To accommodate this problem a Level Shifter is integrated within the e-Link32/e-Link32 Pro to handle different voltage level situations. However, users can also use different power supply modes according to their various target board circuits and application purposes. For example:

- SWD/RESET/UART interface voltage determined by the target board power supply (hardware factory default value):
The VDD power supply on the SWD interface is supplied by the target board. The SWD, RESET and UART interface IO voltages of the e-Link32/e-Link32 Pro will be processed by the Level Shifter to ensure that their voltage level is the same as the target board.
- MCU with independent IO power supply:
The SWD interface voltage is different from the RESET signal. For example, the SWD interface operates at 1.8V while the RESET signal operates at 3.3V.

- Target board power supply provided by the e-Link32/e-Link32 Pro:

The VDD power supply on the SWD interface is supplied with 3.3V by the e-Link32/e-Link32 Pro. In this case, the e-Link32/e-Link32 Pro and the target board MCU will both operate at 3.3V. Users must take care to ensure that the target board can operate at 3.3V and that the current does not exceed the e-Link32/e-Link32 Pro allowed current. This configuration is usually used to simplify the power supply mode during programming. Therefore, the target board does not require an additional power supply.

The following content describes how to adjust the e-Link32 or e-Link32 Pro resistance jumper to meet different power requirements.

- SWD/RESET/UART interface voltage determined by target board power supply (hardware factory default value):

The VDD (Pin 1) power supply on the SWD interface is supplied by the target board. The SWD, RESET and serial communication ^(Note) logic voltages refer to the target board V_{DD} voltage.

Table 2. Power Configuration – SWD/RESET/UART Interface Voltage determined by the Target Board Power Supply

| Resistor | State | Description |
|----------|-----------|--------------------------------|
| R19 | Exist | Factory default, 10kΩ resistor |
| R12 | Non-exist | Factory default |

Note: The serial communication function is only available for the e-Link32 Pro.

- MCU with independent IO power supply - for e-Link32 Pro only:

Similar to the previous configuration mode, the only difference is that the RESET IO voltage level is determined by the pull-high resistor of the target board nRST.

Table 3. Power Configuration – MCU with Independent IO Power Supply

| Resistor | State | Description |
|----------|-----------|-----------------|
| R19 | Non-exist | Remove R19 |
| R12 | Non-exist | Factory default |

- Target board power supply provided by the e-Link32/e-Link32 Pro:

The VDD (Pin 1) power supply on the SWD interface is provided with 3.3V by the e-Link32/e-Link32 Pro. The SWD, RESET and serial interface ^(Note) communication logic voltages refer to the e-Link32/e-Link32 Pro voltage.

Table 4. Power Configuration – Target Board Power Supply Provided by e-Link32/e-Link32 Pro

| Resistor | State | Description |
|----------|-------|--------------------------------|
| R19 | Exist | Factory default, 10kΩ resistor |
| R12 | Exist | Add a 0Ω resistor |

Note: The serial communication function is only available for the e-Link32 Pro.

Dynamically Switching Power Configuration

Users can connect a switch on J4 to dynamically select the following power configurations.

Table 5. Power Supply Switch – J4

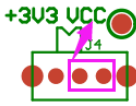
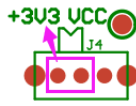
| J4 | Description |
|---|--|
|  | SWD/RESET/UART interface voltage determined by the target board power supply |
|  | Target board power supply provided by the e-Link32/e-Link32 Pro |

e-Link32/e-Link32 Pro Schematic Diagram

This section shows the entire e-Link32 and e-Link32 Pro circuit diagrams.

- e-Link32 v1.0
- e-Link32 Pro v1.0 (HT32F1654)
- e-Link32 Pro v1.0 (HT32F52341)

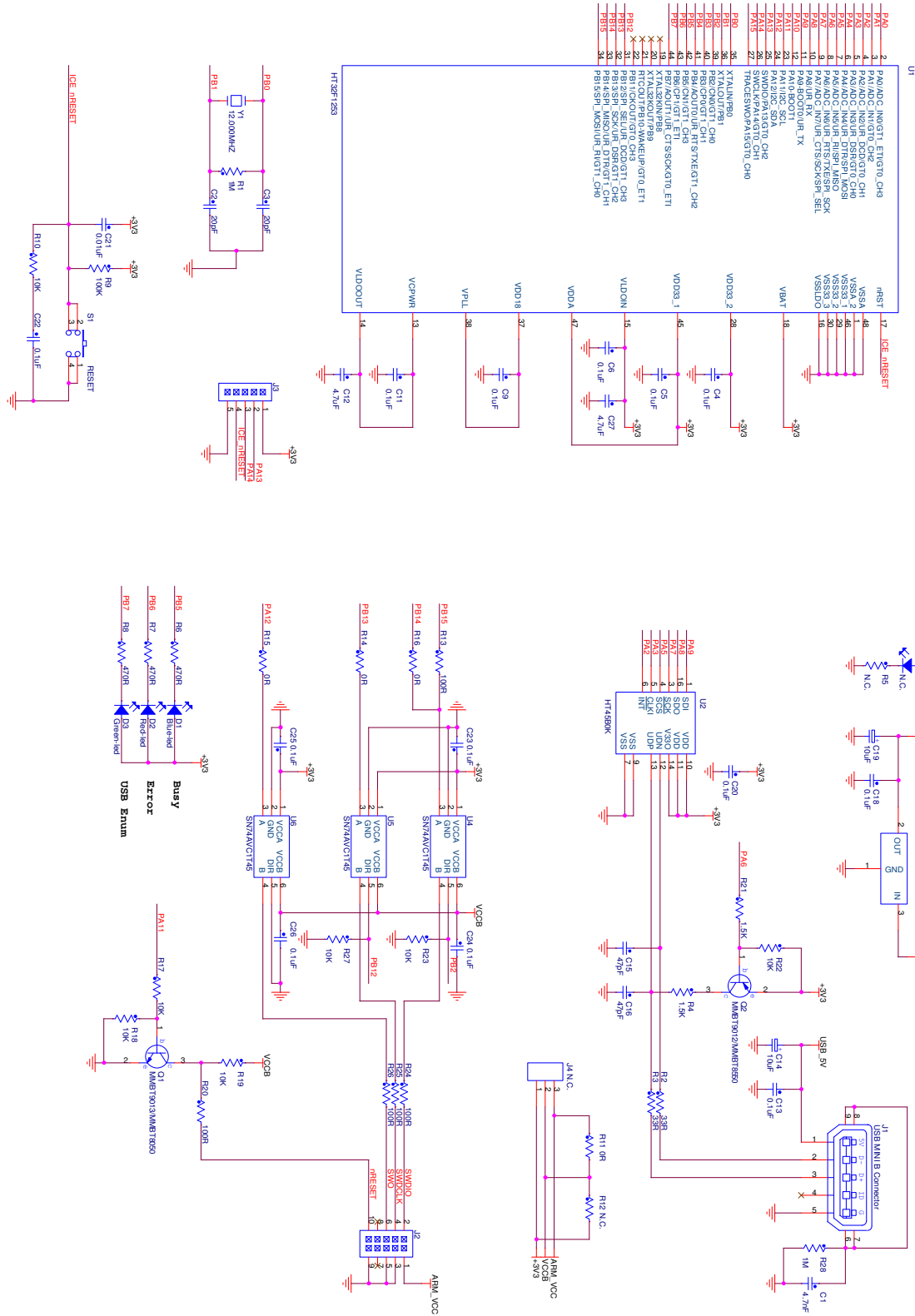

Figure 3. e-Link32 v1.0

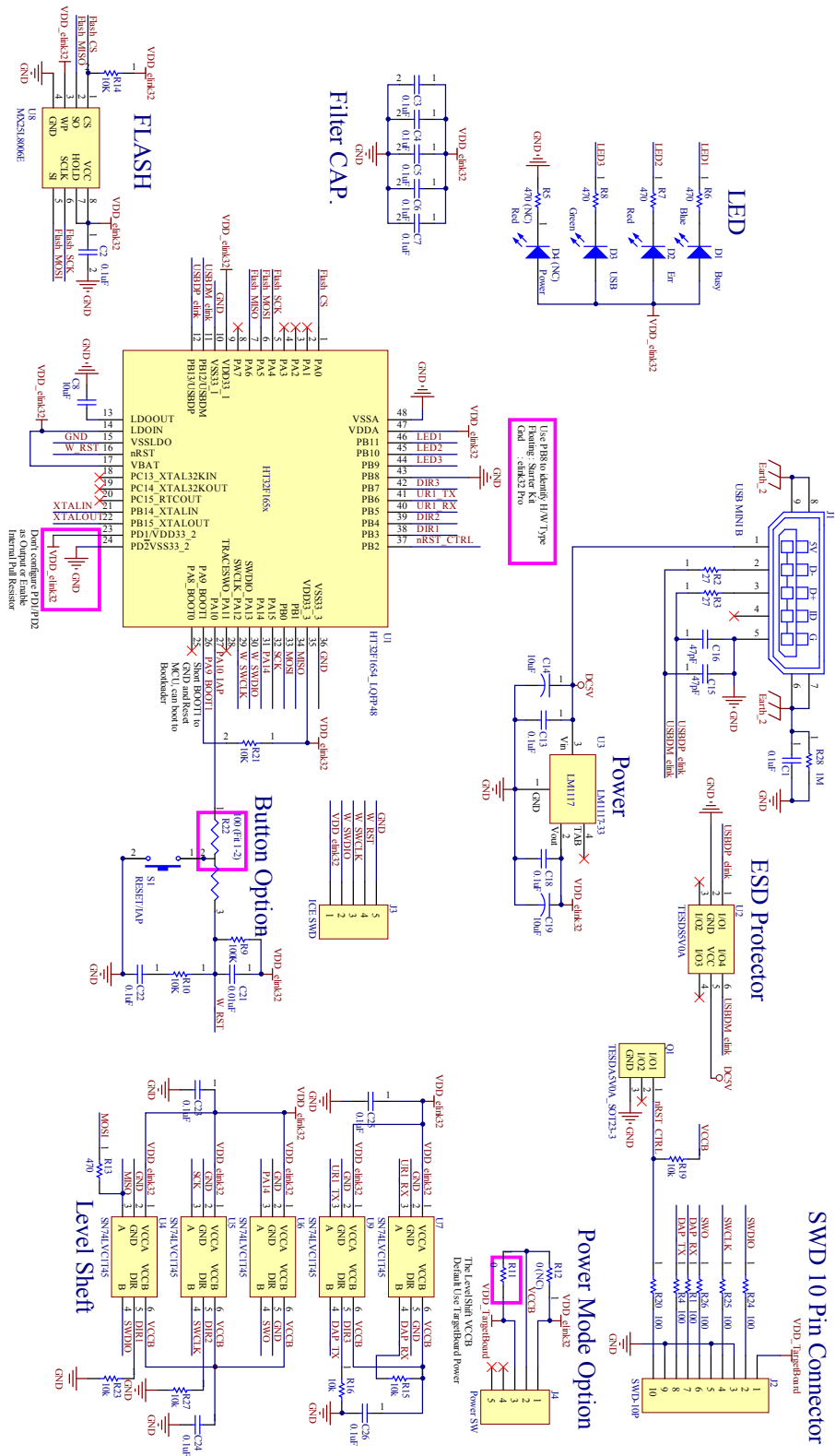

Figure 4. e-Link32 v1.0 (HT32F1654)

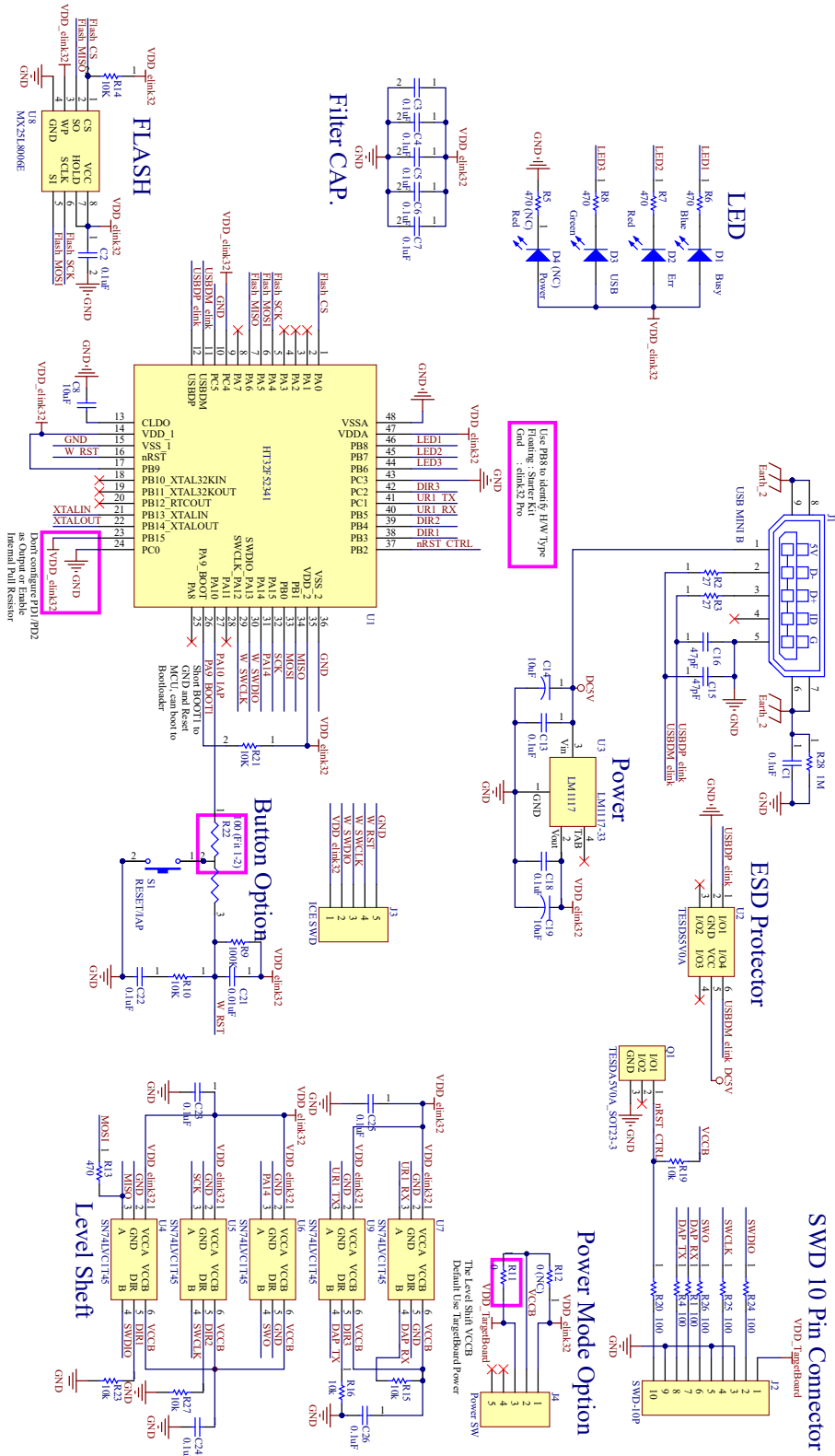

Figure 5. e-Link32 Pro v1.0 (HT32F52341)

2 MDK_ARM (KEIL) Setup and Use

e-Link32/e-Link32 Pro for Keil Installation

The following steps show how to install the e-Link32/e-Link32 Pro for Keil:

- Double-click “HT32_Setup_Keil_vxx.exe” to open the Keil Boot program and press the “Yes” button to continue.

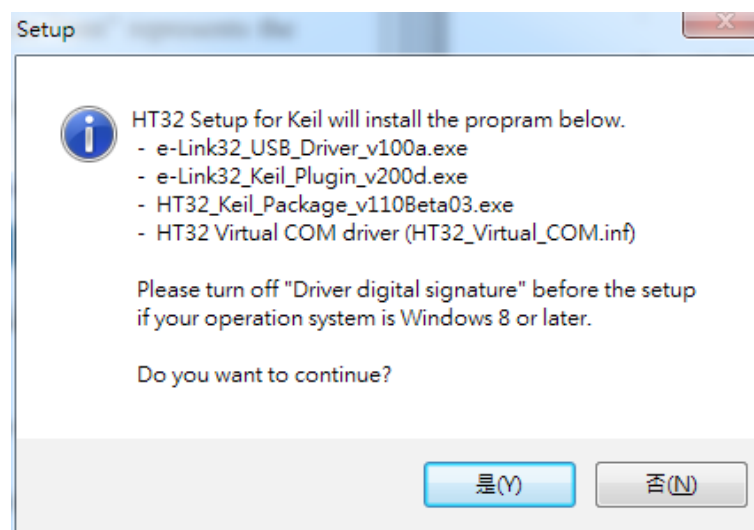

Figure 6. HT32_Setup_Keil_vxx.exe Installation Introduction

- The default installation path of the Keil Boot program is “C:\Program Files (x86)\HT32_Setup_Keil”. Select the desired installation path and press the “Next” button to continue.

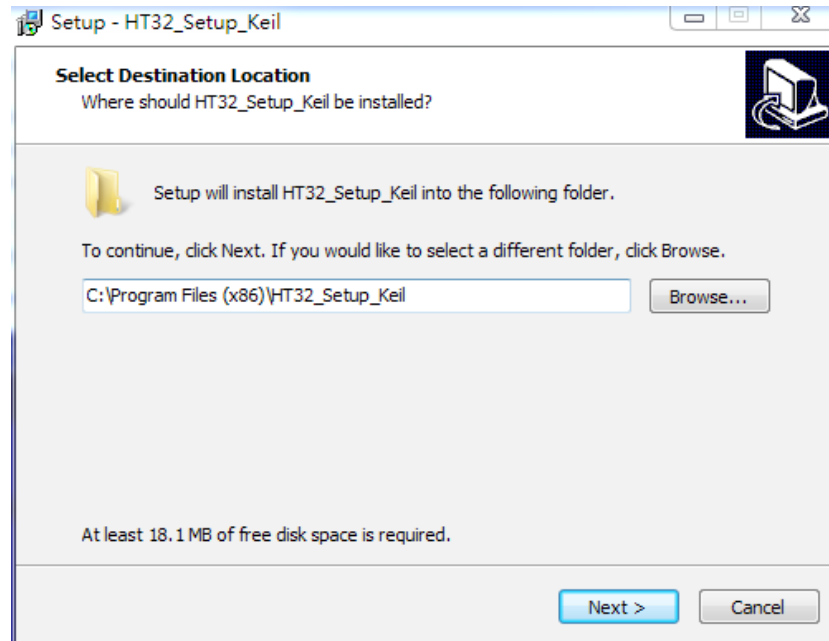

Figure 7. HT32_Setup_Keil_vxx.exe Installation Path

- Press the “Install” button to start the installation.

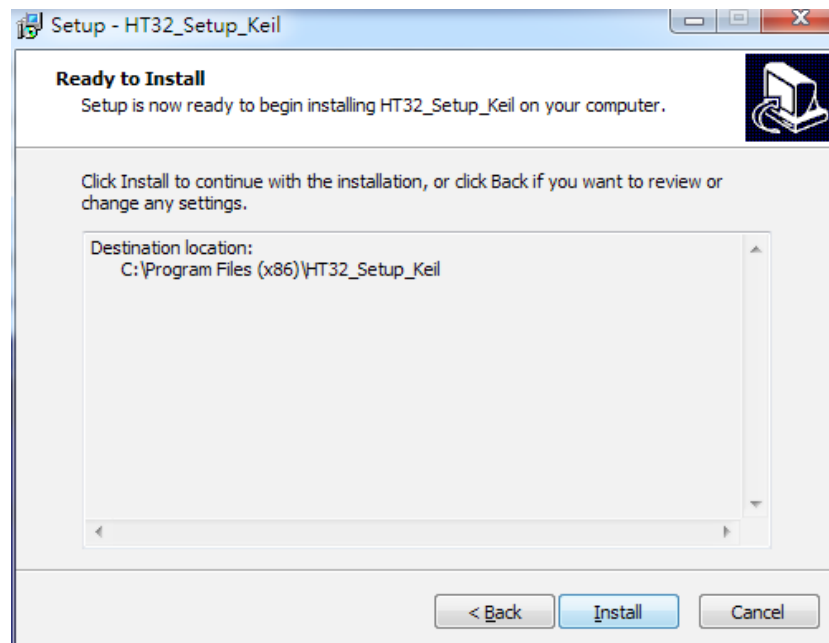

Figure 8. HT32_Setup_Keil_vxx.exe Installation Process

- Once the installation has finished, the following screen will appear. Press the “Next” button to install the “Holtek e-Link32 USB Driver”.

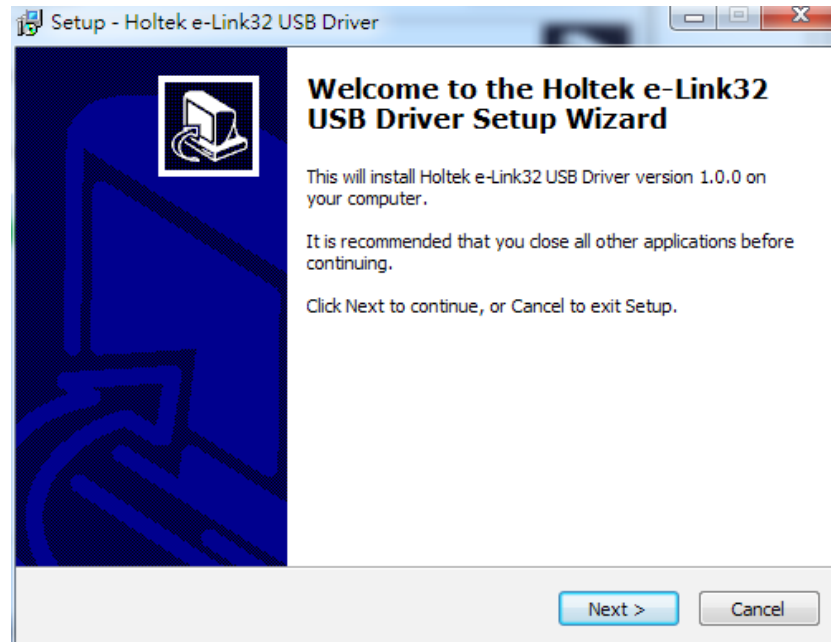

Figure 9. Holtek e-Link32 USB Driver Installation Introduction

- The default installation path of the Holtek e-Link32 USB Driver is “C:\Program Files (x86)\Holtek HT32 Series\e-Link32 USB Driver”. Select the desired installation path and press the “Next” button to install.

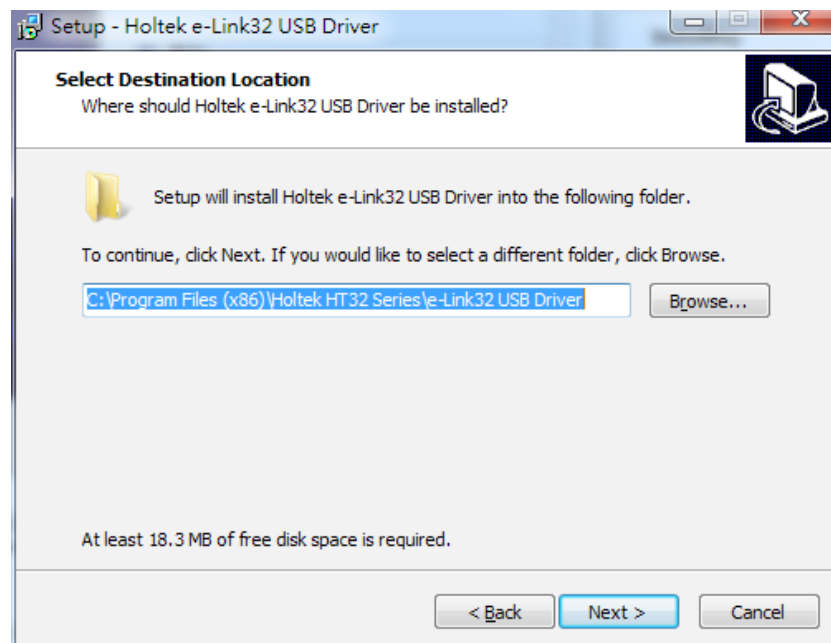

Figure 10. Holtek e-Link32 USB Driver Installation Path

- Once the installation has finished, the following screen will appear. Press the “Finish” button to enter the next Keil Plugin installation process.

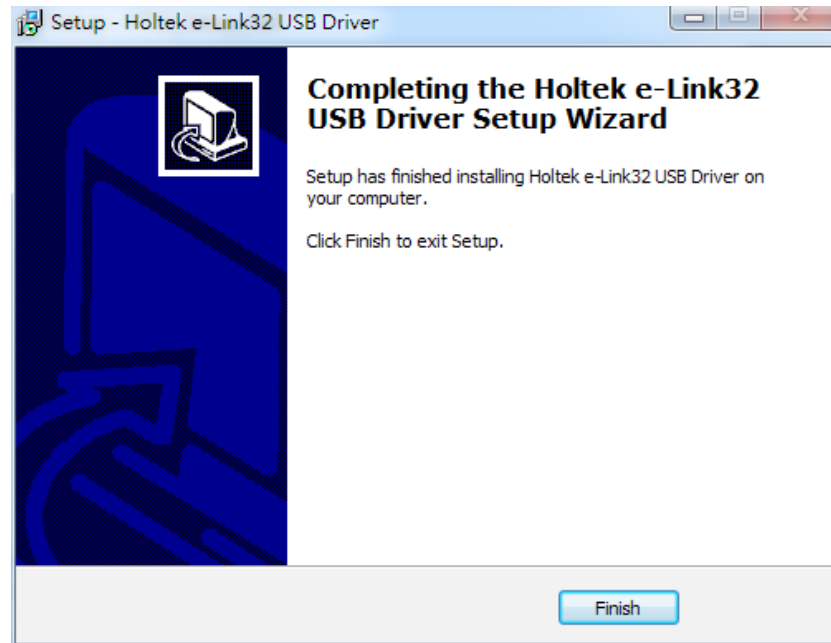

Figure 11. Holtek e-Link32 USB Driver Installation Completion

- If the Holtek e-Link32 Keil Plugin has already been installed, users will be prompted to uninstall any older versions. Press the “Yes” button to continue.

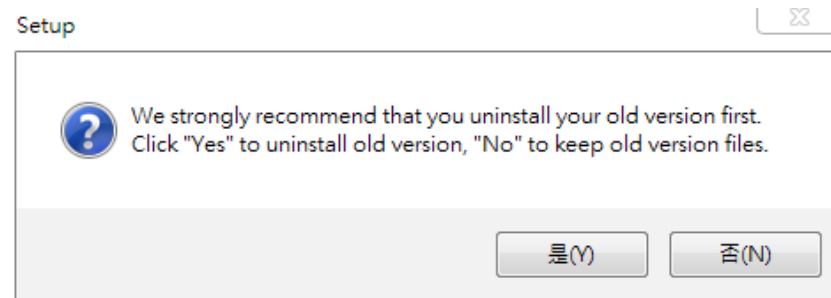

Figure 12. Holtek e-Link32 Keil Plugin Old Version Uninstallation

- Once the uninstallation has finished in the previous step, a Holtek e-Link32 Keil Plugin installation window will appear. Press the “Next” button to continue.

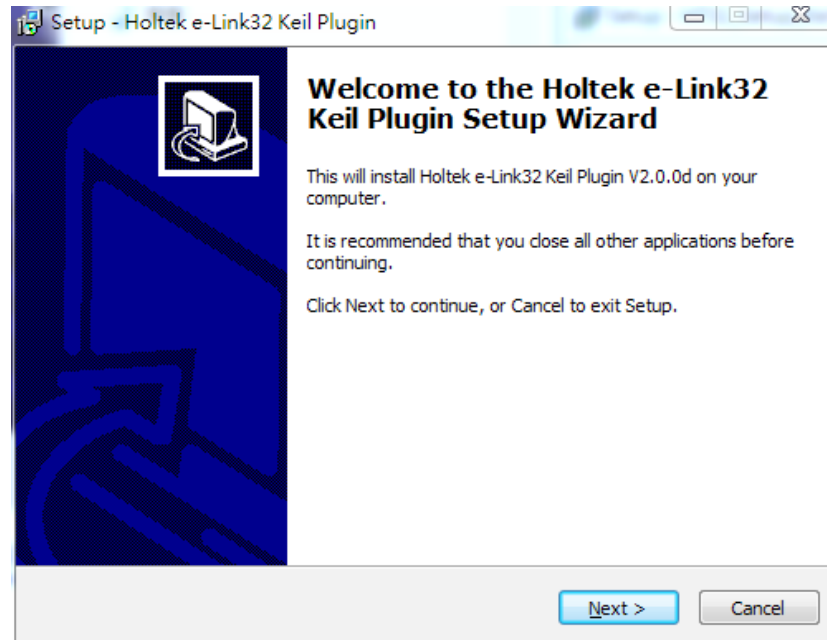

Figure 13. Holtek e-Link32 Keil Plugin Installation Introduction

- The Keil Plugin installation path is subject according to that of Keil4/Keil5. The default installation path of the Keil4/Keil5 is “C:\Keil_xx”. Select the desired installation path and press the “Next” button to install.

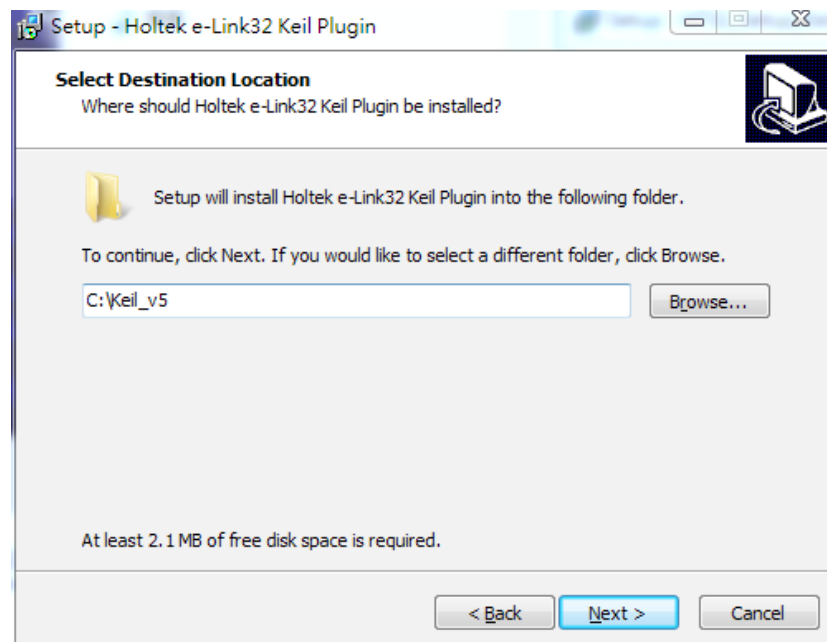

Figure 14. Holtek e-Link32 Keil Plugin Installation Path

- Once the installation has finished, press the “Finish” button to enter the next Holtek HT32 Keil Support Package installation process, then press the “Next” button to continue.

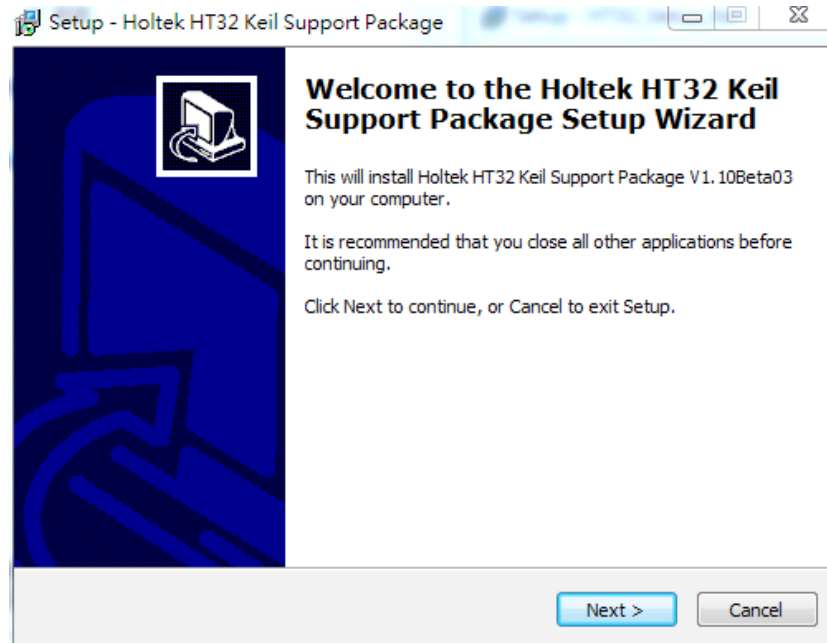

Figure 15. Holtek HT32 Keil Support Package Installation Introduction

- The Keil Support Package installation path is subject to that of the Keil4/Keil5. The default installation path of the Keil4/Keil5 is “C:\Keil_xx”. Select the desired installation path and press the “Next” button to install.

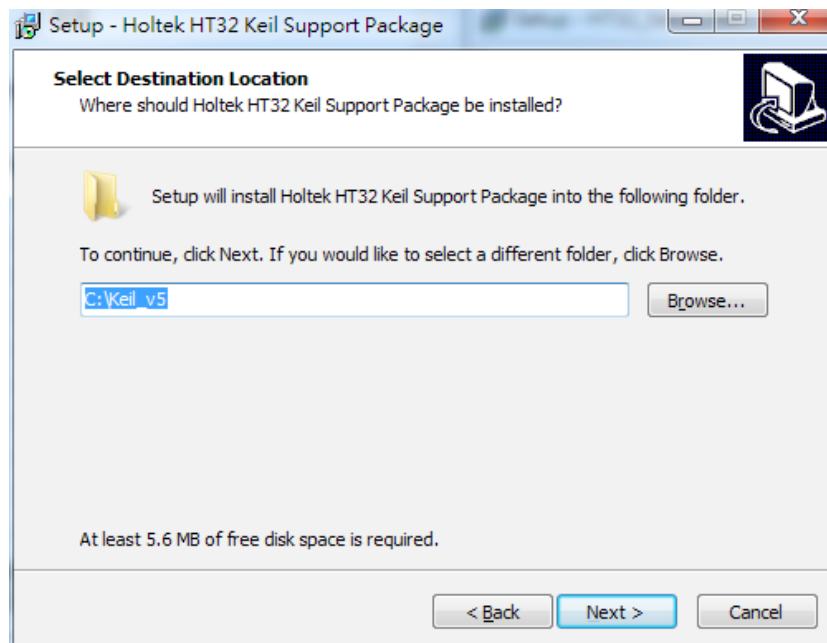

Figure 16. Holtek HT32 Keil Support Package Installation Path

- Once the installation has finished, press the “Finish” button to enter. The completed window will be displayed after which the “Finish” button should be selected to restart the computer.

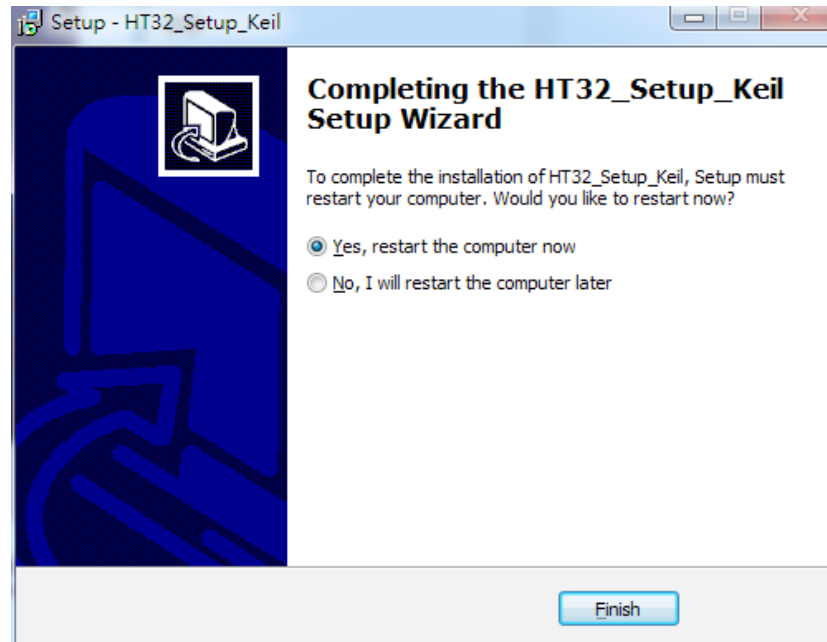

Figure 17. Keil Installation Completion

- Connect the e-Link32/e-Link32 Pro to the PC's USB port.
- Open the PC's “Device Manager” to check the connection status of the e-Link32/e-Link32 Pro.
- If the e-Link32 is connected, a connection device named “Holtek e-Link32 Debug Interface” will appear on the “Device Manager” window. This will confirm that the installation has been successful.

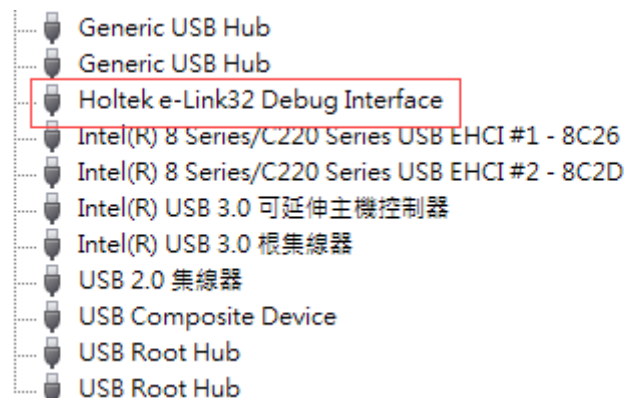

Figure 18. e-Link32 Device Name

- If the e-Link32 Pro is connected, a connection device named “HID-compliant device” will appear on the “Device Manager” window, and the corresponding Virtual COM Port will also be found, confirming that the installation was successful.



Figure 19. e-Link32 Pro Device Name

e-Link32/e-Link32 Pro with Keil4 Setup and Use

- Open the Keil uVision4 project, click “Options for Target”, then click the “Debug” option to select “Holtek e-Link32 Debugger” for e-Link32 or select “CMSIS-DAP Debugger” for e-Link32 Pro.

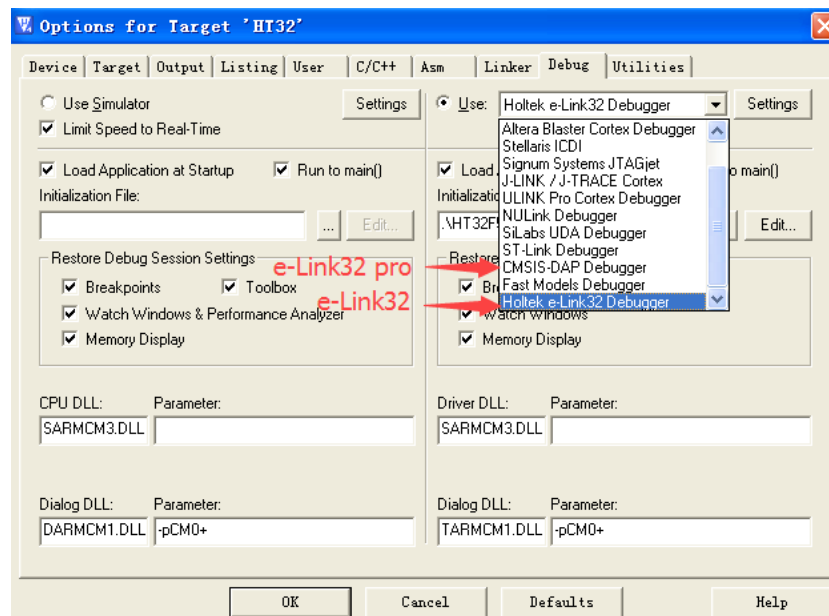

Figure 20. Keil4 Debugger Selection

- After the debugger is selected, click the “Settings” button on the right side to open the corresponding setting window. Confirm that the setting is successful when the device ID is read. The e-Link32 setting window is shown below:

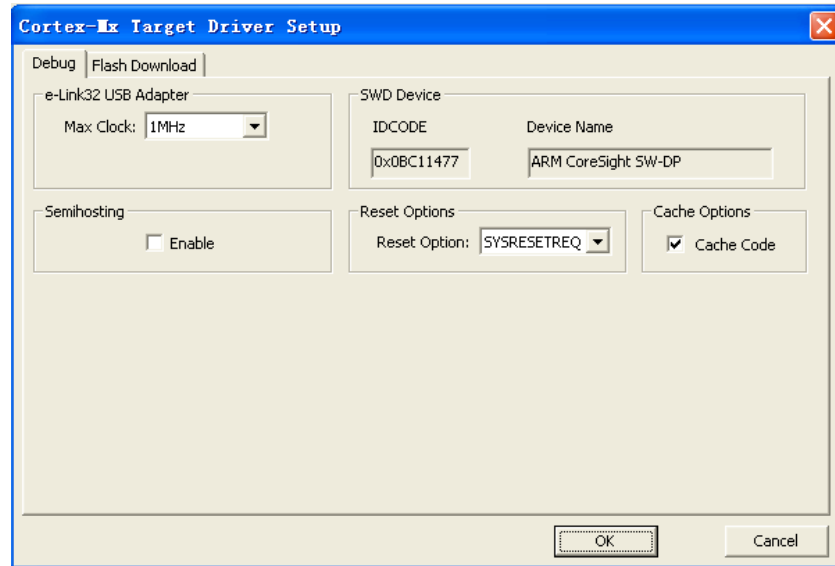

Figure 21. Keil4 e-Link32 Setting Window

The e-Link32 Pro setting window is shown below:
Select SW mode as the Port type.

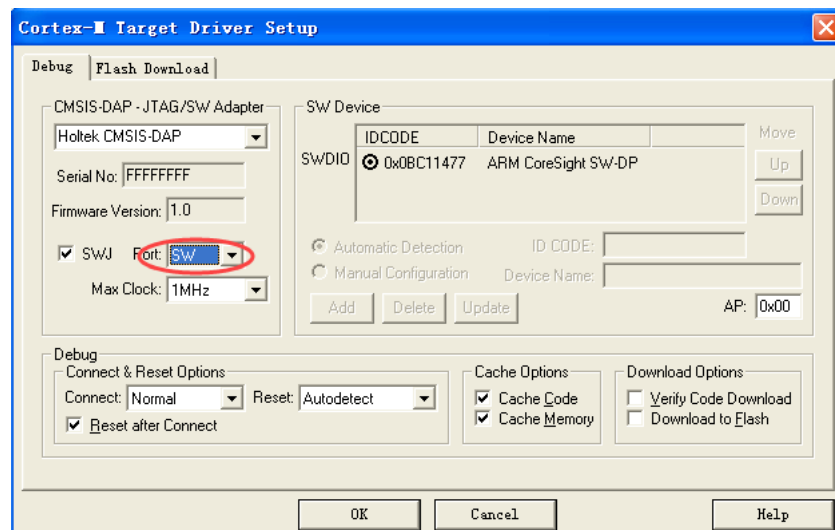

Figure 22. Keil4 e-Link32 Pro Setting Window

- Click “Flash Download” to check the “Programming Algorithm”, if there is no content or the content is not correct, then press the “Add” button.

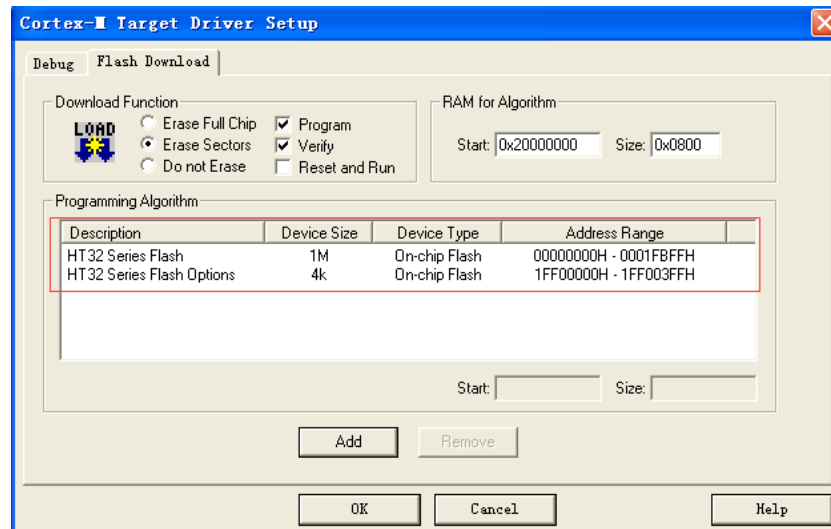

Figure 23. Keil4 - Flash Download Setup

e-Link32 Pro with Keil5 Setup and Use (No Support e-Link32)

- Open the Keil uVision5 project, click “Options for Target”, and select “CMSIS-DAP Debugger” in the “Debug” option.

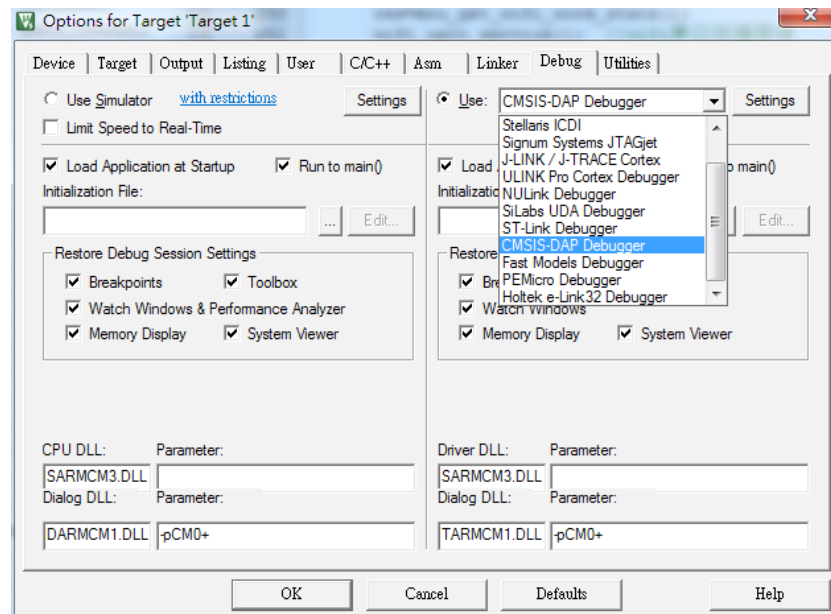

Figure 24. Keil5 Debugger Selection

- After the debugger is selected, click the “Settings” button on the right side to select the SW options. Confirm that the setting is successful when the device ID is read.

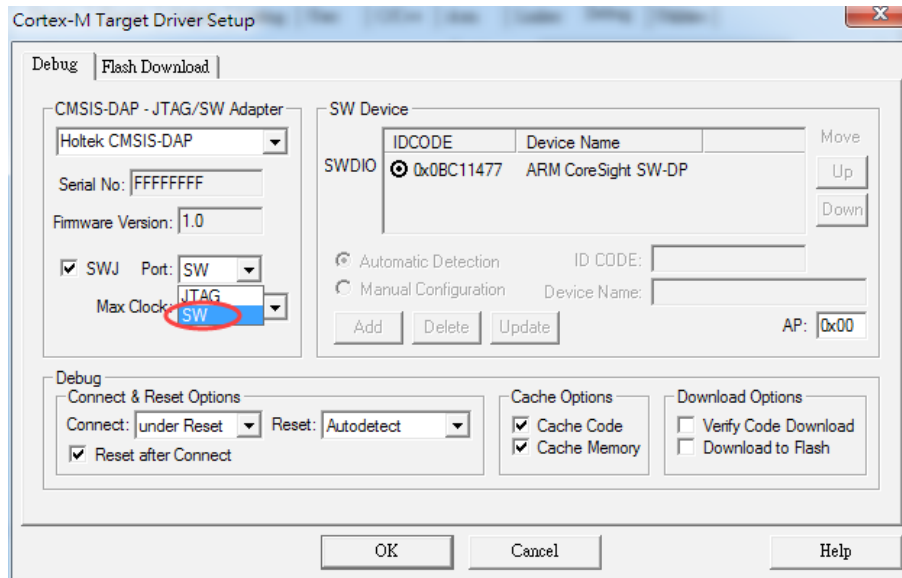

Figure 25. Keil5 Debugger Setup

- Click “Flash Download” to check “Programming Algorithm”, if there is no content or the content is not correct, then press the “Add” button.

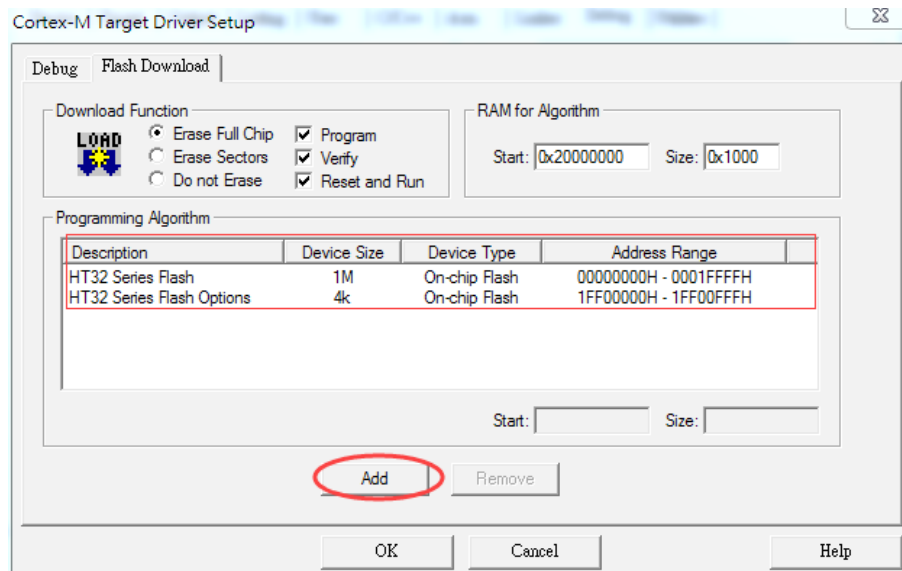

Figure 26. Keil5 – Flash Download Setup

3 IAR Setup and Use

e-Link32/e-Link32 Pro for IAR Installation

The following steps show how to install the e-Link32/e-Link32 Pro for IAR:

- Double-click “HT32_Setup_IAR_vxx.exe” to open the IAR Boot program and press the “Yes” button to continue.

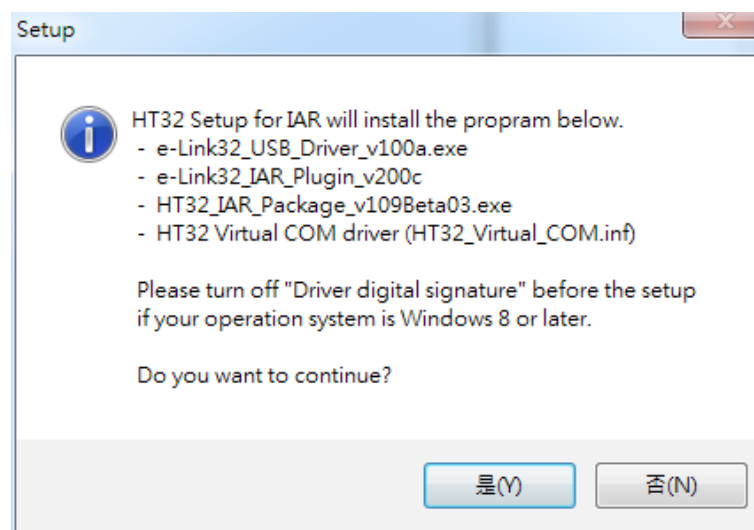

Figure 27. HT32_Setup_IAR_vxx.exe Installation Introduction

- The default installation path of the IAR Boot program is “C:\Program Files (x86)\HT32_Setup_IAR”. Select the desired installation path and press the “Next” button to continue.

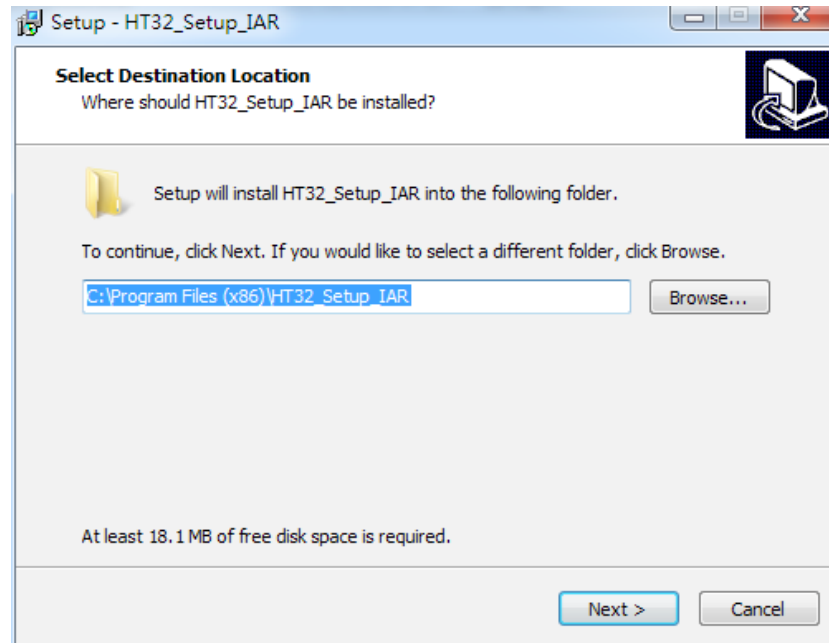

Figure 28. HT32_Setup_IAR_vxx.exe Installation Path

- Press the “Install” button to start the installation.

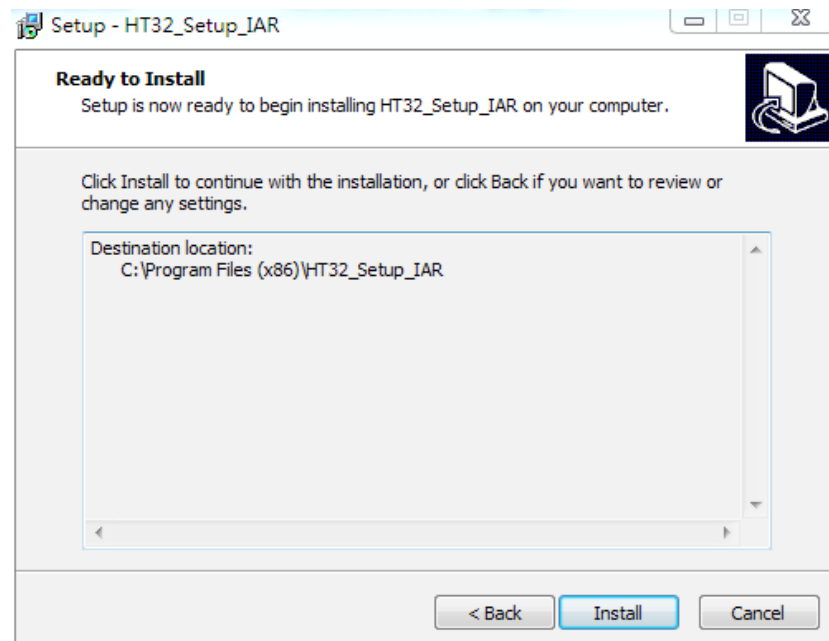

Figure 29. HT32_Setup_IAR_vxx.exe Installation Process

- Once the installation has finished, the following screen will appear. Press the “Next” button to install the “Holtek e-Link32 USB Driver”.

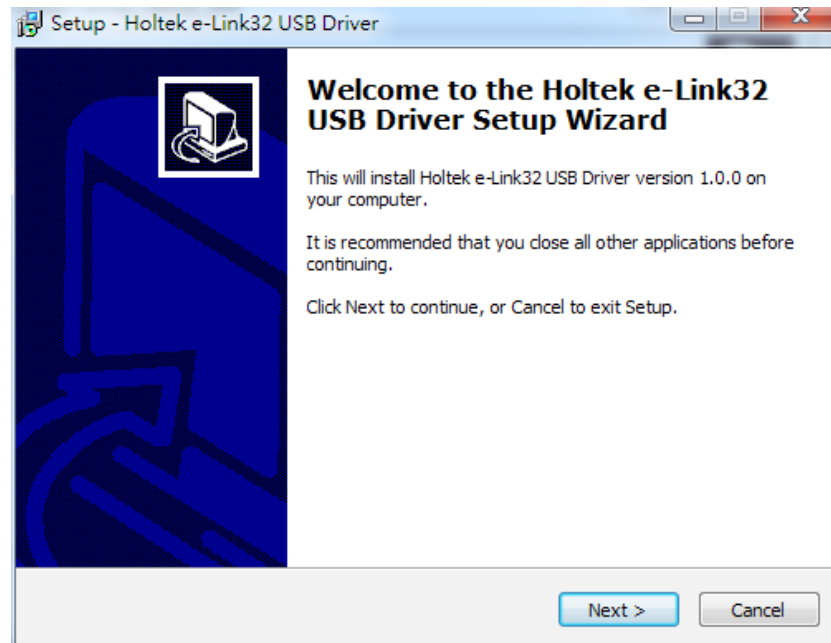

Figure 30. Holtek e-Link32 USB Driver Installation Introduction

- The default installation path of the Holtek e-Link32 USB Driver is “C:\Program Files (x86)\Holtek HT32 Series\e-Link32 USB Driver”. Select the desired installation path and press the “Next” button to install.

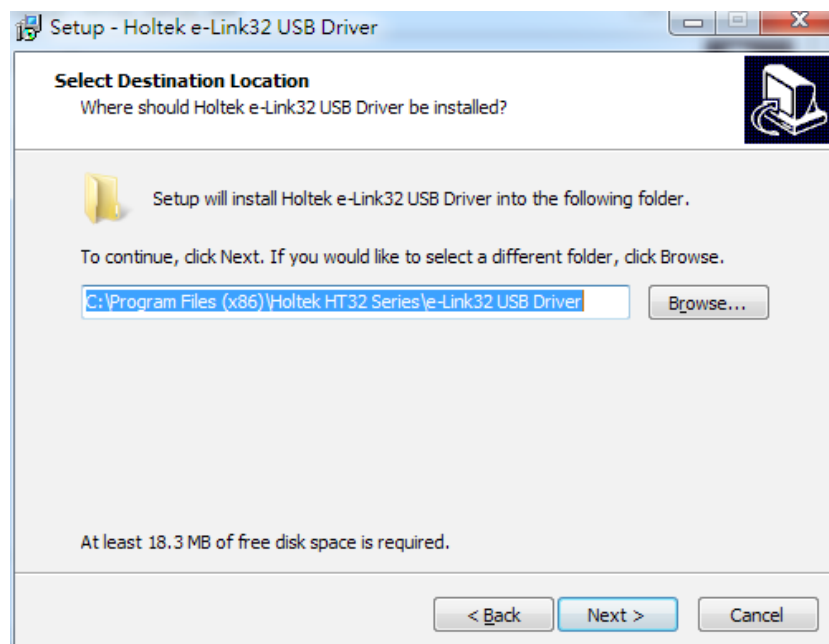

Figure 31. Holtek e-Link32 USB Driver Installation Path

- Once the installation has finished, the following screen will appear. Press the “Finish” button to enter the next IAR Plugin installation process.

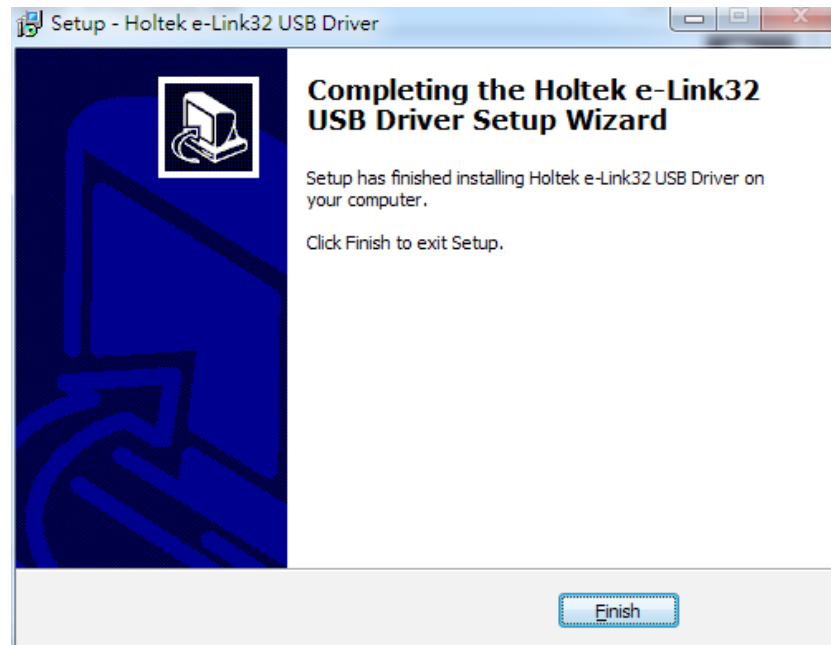

Figure 32. Holtek e-Link32 USB Driver Installation Completion

- If the Holtek e-Link32 IAR Plugin has already been installed, users are prompted to uninstall any older versions. Press the “Yes” button to continue.

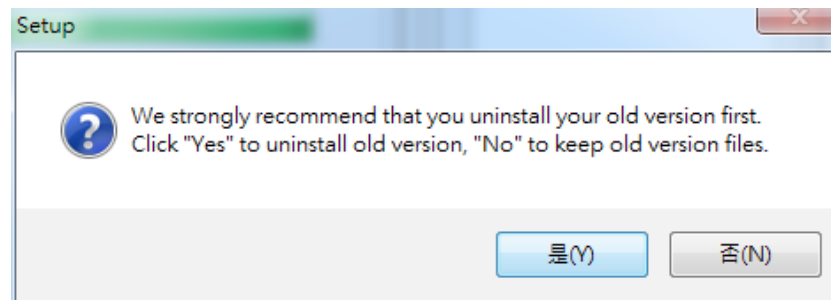

Figure 33. Holtek e-Link32 IAR Plugin Old Version Uninstallation

- Once the uninstallation has finished in the previous step, a Holtek e-Link32 IAR Plugin installation window will appear. Press the “Next” button to continue.

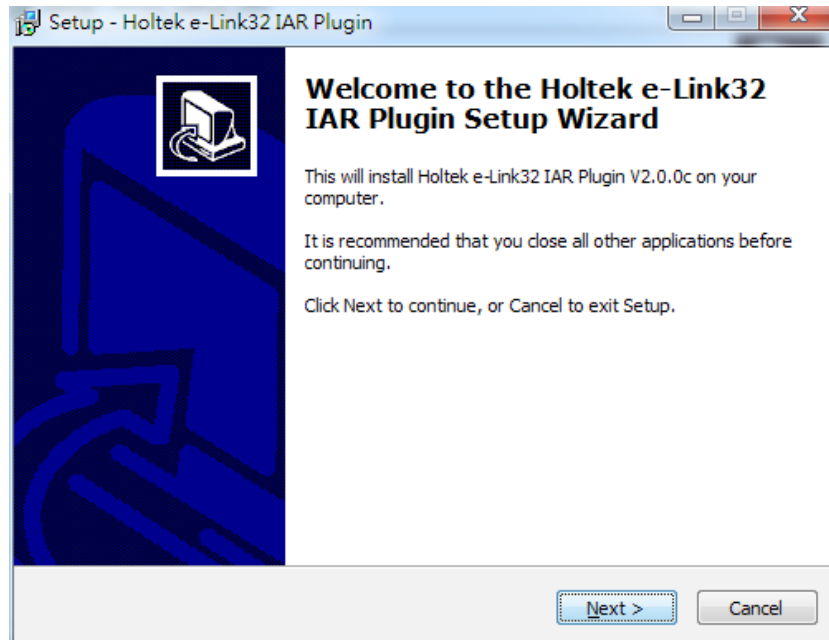

Figure 34. Holtek e-Link32 IAR Plugin Installation Introduction

- The default installation path of the IAR Plugin is “C:\Program Files\Holtek HT32 Series\e-Link32 IAR Plugin”. Select the desired installation path and press the “Next” button to install.

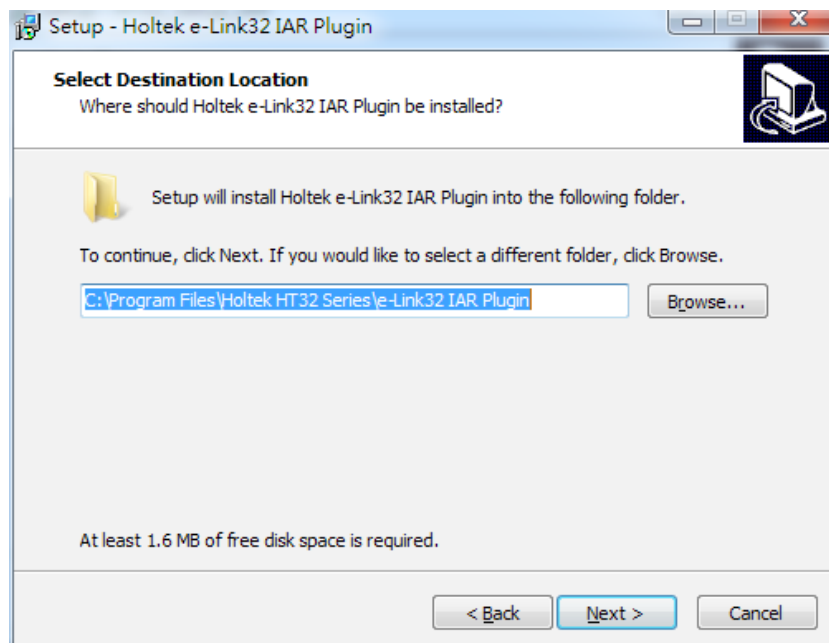

Figure 35. Holtek e-Link32 IAR Plugin Installation Path

- Once the installation has finished, press the “Finish” button to enter the next Holtek HT32 IAR Support Package installation process, then press the “Next” button to continue.

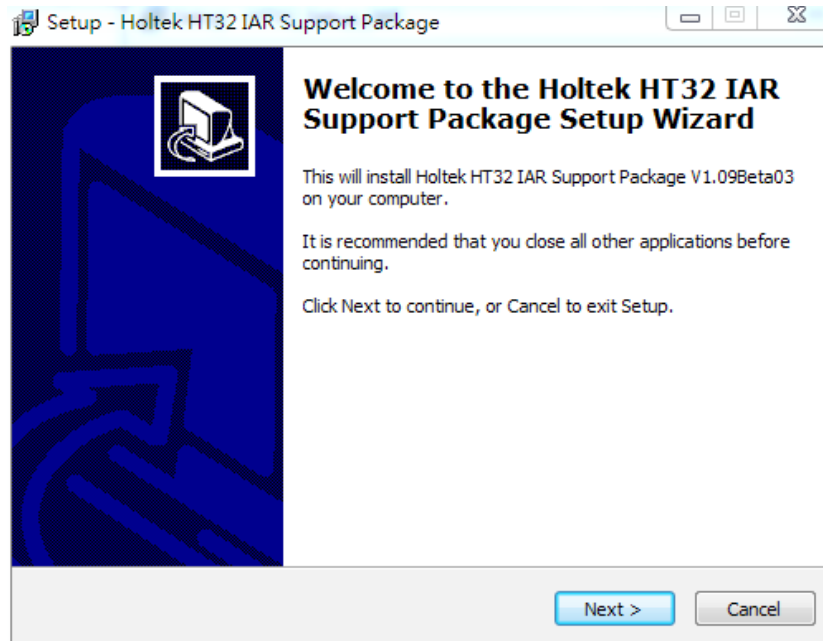

Figure 36. Holtek HT32 IAR Support Package Installation Introduction

- Once the installation has finished, press the “Finish” button.
- Connect the e-Link32/e-Link32 Pro to the PC’s USB port.
- Open the PC’s “Device Manager” to check the connection status of the e-Link32/e-Link32 Pro.
- If the e-Link32 is connected, a connection device named “Holtek e-Link32 Debug Interface” will appear on the “Device Manager” window, confirming that the installation has been successful.

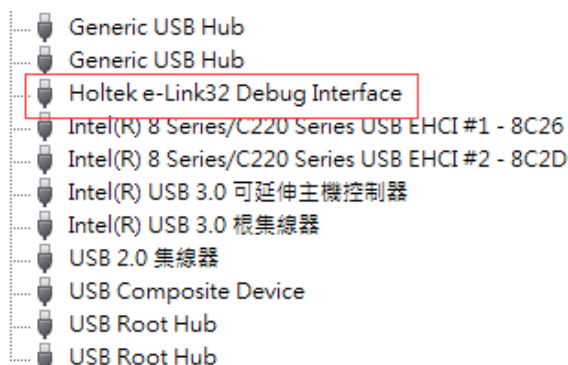

Figure 37. e-Link32 Device Name

- If the e-Link32 Pro is connected, a connection device named “HID-compliant device” will appear on the “Device Manager” window, and the corresponding Virtual COM Port will also be found, confirming that the installation has been successful.



Figure 38. e-Link32 Pro Device Name

e-Link32/e-Link32 Pro with IAR EWARM Setup and Use

- Open the IAR EWARM project, and then open “Options”.

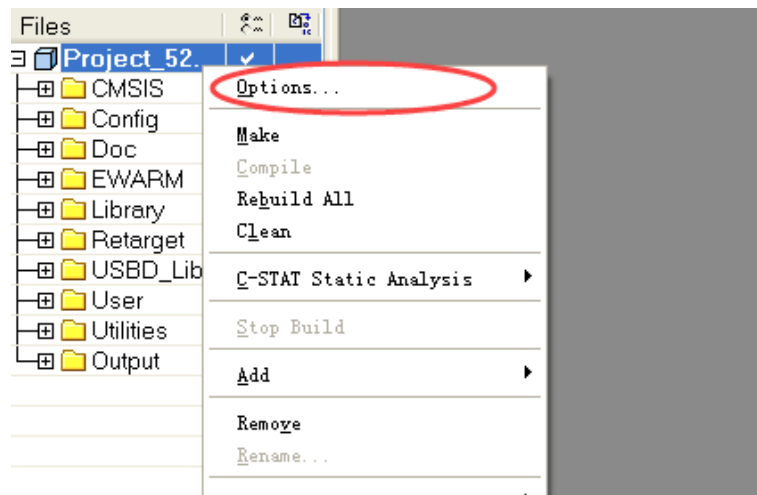

Figure 39. IAR Options

- Click “Debugger” to select “RDI” for e-Link32 or select “CMSIS DAP” for e-Link32 Pro.

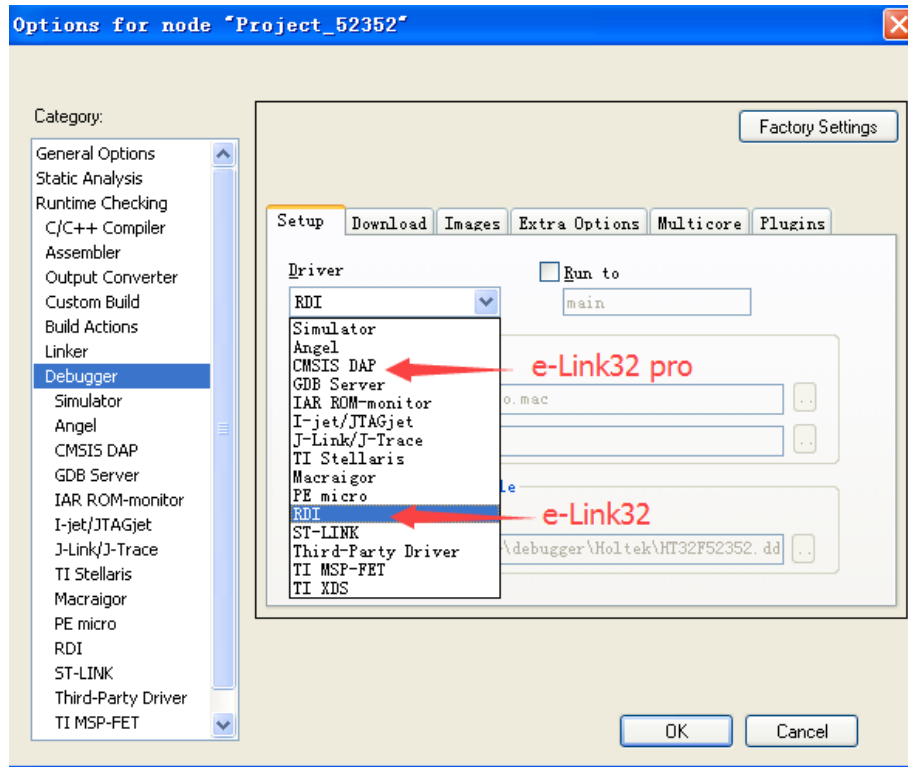

Figure 40. IAR Debugger Selection

- Setting the selected debugger.
Check whether “e-Link32_rdi.dll” is selected in “Manufacturer RDI driver” for e-Link32 RDI.

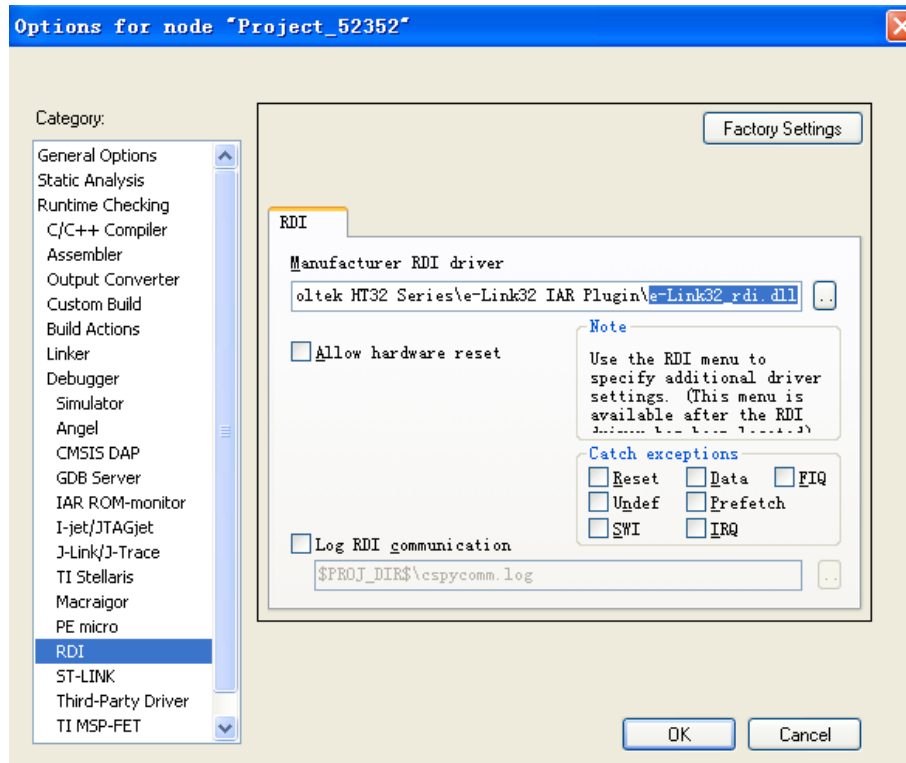

Figure 41. IAR e-Link32 Debugger Setup

Switch Interface option to SWD mode for e-Link32 Pro CMSIS DAP.

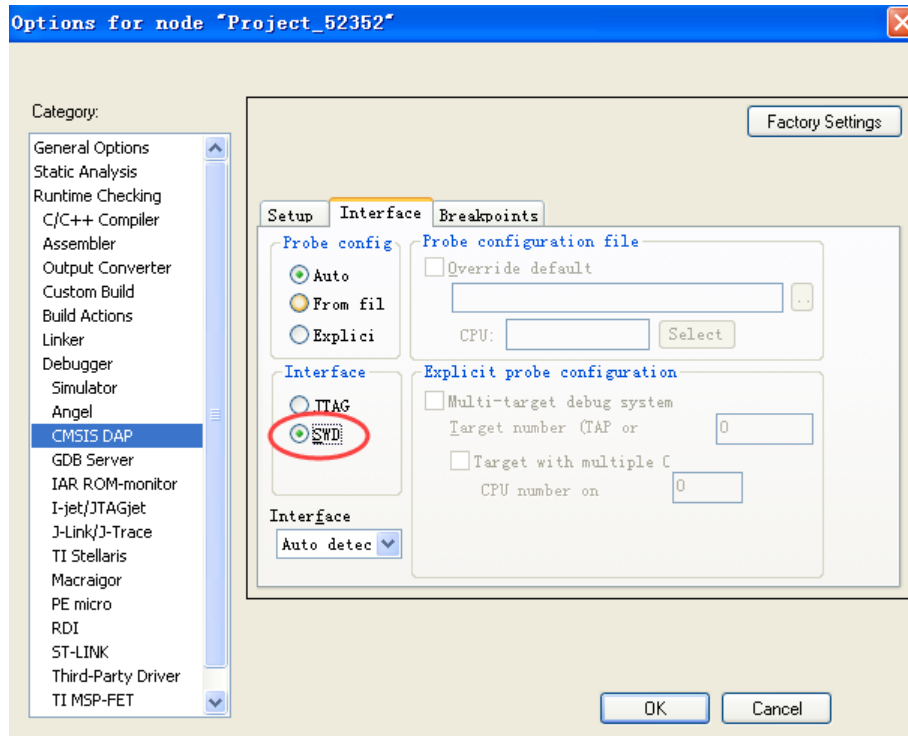

Figure 42. IAR e-Link32 Pro Debugger Setup

- Once the settings have finished, the corresponding debugger options will appear on the function table.

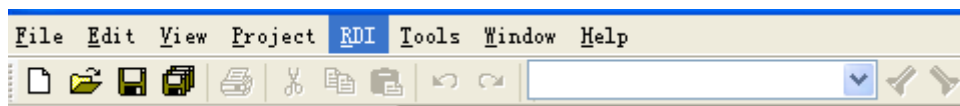

Figure 43. IAR e-Link32 Debugger Function Table



Figure 44. IAR e-Link32 Pro Debugger Function Table

Copyright© 2020 by HOLTEK SEMICONDUCTOR INC.

The information appearing in this Data Sheet is believed to be accurate at the time of publication. However, Holtek assumes no responsibility arising from the use of the specifications described. The applications mentioned herein are used solely for the purpose of illustration and Holtek makes no warranty or representation that such applications will be suitable without further modification, nor recommends the use of its products for application that may present a risk to human life due to malfunction or otherwise. Holtek's products are not authorized for use as critical components in life support devices or systems. Holtek reserves the right to alter its products without prior notification. For the most up-to-date information, please visit our web site at <http://www.holtek.com>.