

### MLN SurgeArray™ Suppressor

RoHS



#### Size Table

Metric	EIA
3216	1206

#### Absolute Maximum Ratings

Continuous	MLN Series	Units
Steady State Applied Voltage:		
DC Voltage Range ( $V_{MDC}$ )	5.5 - 18	V
Operating Ambient Temperature Range ( $T_A$ )	-55 to +125	°C
Storage Temperature Range ( $T_{STG}$ )	-55 to +150	°C

For ratings of individual members of a series, see device ratings and specifications table.

#### Additional Information



**Datasheet**



**Resources**



**Samples**

#### Description

The MLN SurgeArray™ Suppressor is designed to help protect components from transient voltages that exist at the circuit board level. This device provides four independent suppressors in a single leadless chip in order to reduce part count and placement time as well as save space on printed circuit boards.

SurgeArray™ Suppressor are intended to suppress ESD, EFT and other transients in order to protect integrated circuits or other sensitive components operating at any voltage up to  $18V_{DC}$ . SurgeArray™ Suppressor are rated to the IEC 61000-4-2 human body model ESD to help products attain EMC compliance. The array offers excellent isolation and low crosstalk between sections.

The inherent capacitance of the SurgeArray™ Suppressor permits it to function as a filter/suppressor, thereby replacing separate Zener/capacitor combinations.

The MLN array is manufactured using the Littelfuse Multilayer technology process and is similar to the Littelfuse ML and MLE Series of discrete leadless chips.

#### Features

- RoHS Compliant
- Four individual devices in one chip
- ESD rated to IEC 61000-4-2 (Level 4)
- AC characterized for impedance and capacitance
- Low adjacent channel crosstalk, -55dB at 10MHz (Typ)
- Low leakage
- Operating voltage up to  $18V_{MDC}$
- -55°C to 125°C operating temp range
- Low-profile, PCMCIA compatible

#### Applications

- Data, Diagnostic I/O Ports
- Analog Signal/Sensor Lines
- Portable/Hand-Held Products
- Mobile
- Communications/Cellular Phones
- Computer/DSP Products
- Industrial Instruments Including Medical

### Device Ratings and Specifications Any Single Section

Part Number	Maximum Ratings (125°C)			Specifications (25°C)							
	Maximum Continuous Working Voltage	Maximum Non-repetitive Surge Current (8/20 $\mu$ s)	Maximum Non-repetitive Surge Energy (10/1000 $\mu$ s)	Maximum Clamping Voltage (at Noted 8/20 $\mu$ s Current)	Typical ESD Suppression Voltage (Note1)			Nominal Voltage at 1 mA DC Test Current		Capacitance at 1 MHz (1V p-p)	
	$V_{M(DC)}$	$I_{TM}$	$W_{TM}$	$V_C$	(Note 2) 8kV Contact		(Note 3) 15kV Air	$V_{N(DC)}$ Min	$V_{N(DC)}$ Max	(Note 4) C	
					Peak	Clamp	Peak			TYP	MAX
(V)	(A)	(J)	(V)	(V)	(V)	(V)	(V)	(V)	(pF)	(pF)	
V5.5MLN41206	5.5	30	0.10	15.5 at 2A	60	35	45	7.10	10.8	430	520
V9MLN41206	9.0	30	0.10	23.0 at 2A	95	50	75	11.0	16.0	250	300
V14MLN41206	14.0	30	0.10	30.0 at 2A	110	55	85	15.9	20.3	140	175
V18MLN41206	18.0	30	0.10	40.0 at 2A	165	63	100	22.0	28.0	100	125
V18MLN41206L	18.0	30	0.05	50.0 at 1A	200	95	130	25.0	35.0	45	75

NOTES: 1. Tested to IEC61000-4-2 Human Body Model (HBM) discharge test circuit.  
 2. Direct discharge to device terminals (IEC preferred test method).  
 3. Corona discharge through air (represents actual ESD event)

4. Capacitance may be customized, contact Sales.  
 5. The typical capacitance rating is the discrete component test result.

### Peak Current and Energy Derating Curve

For applications exceeding 125°C ambient temperature, the peak surge current and energy ratings must be reduced.

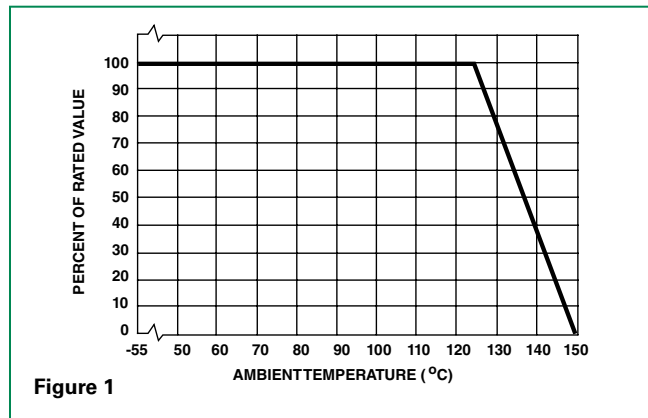

Figure 1

### Peak Pulse Current Test Waveform for Clamping Voltage

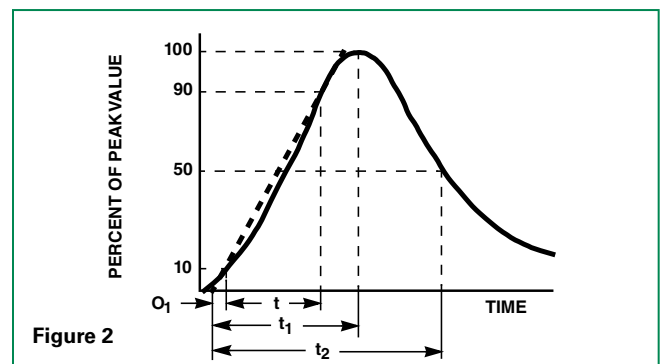

Figure 2

$O_1$  = Virtual Origin of Wave

$T$  = Time from 10% to 90% of Peak

$T_1$  = Rise Time =  $1.25 \times T$

$T_2$  = Decay Time

(Impulse Duration)

**Example:**

For an 8/20  $\mu$ s Current Waveform:

$8\mu s = T_1$  = Rise Time

$20\mu s = T_2$  = Virtual Time

to Half Value

### Typical Performance Curves

#### Equivalent Series Resistance

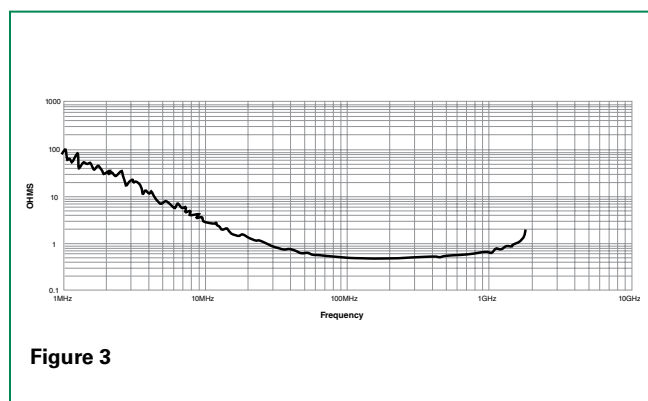

Figure 3

#### Impedance vs Frequency, 1206 Size

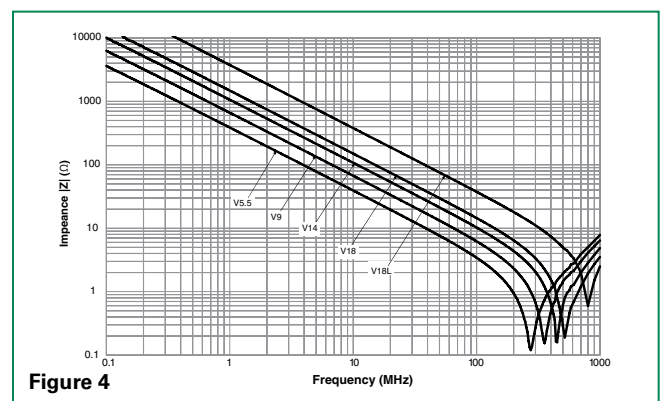
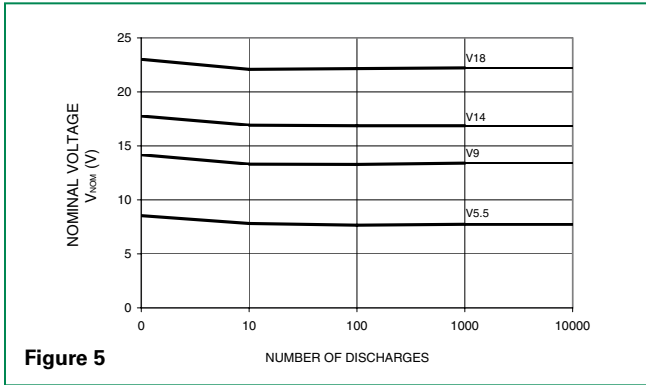

Figure 4

**Typical Performance Curves (continued)**

**Nominal Voltage Stability to IEC 1000-4-2 (8kV Contact Method, One Section)**



**Figure 5**

**1206 Size Pulse Rating for Long Duration Surges (Any Single Section)**

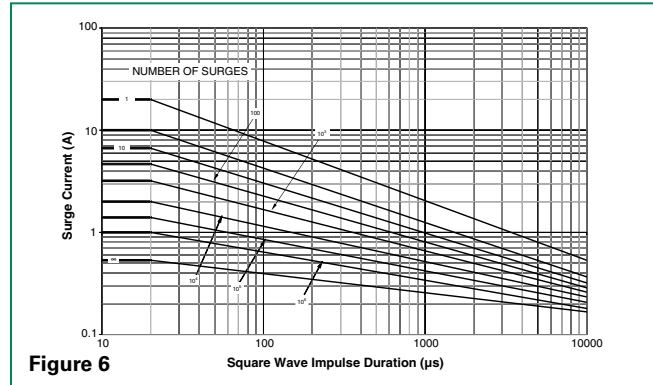

**Figure 6**

**V-I Characteristic, 1206 size**

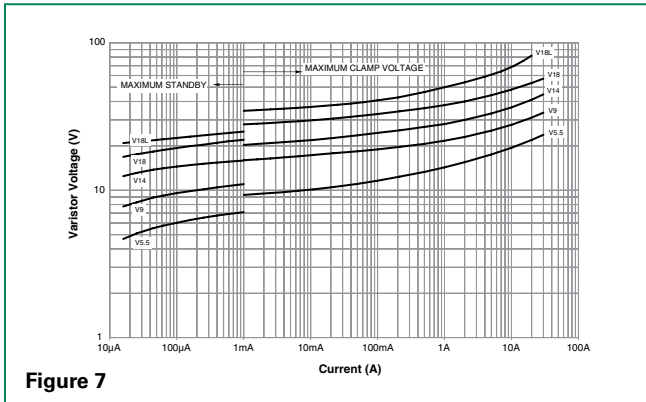

**Figure 7**

**Capacitance vs Frequency, 1206 Size**

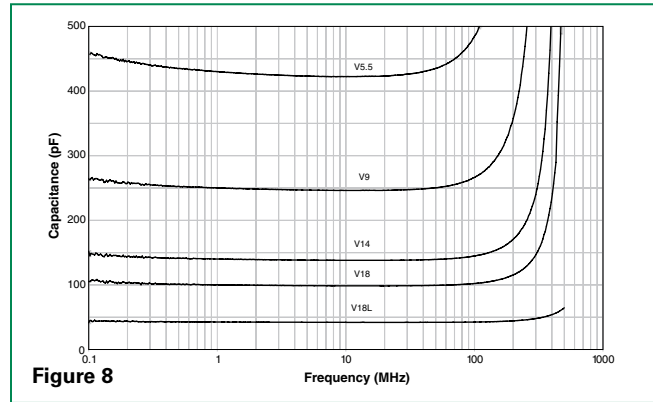

**Figure 8**

**Adjacent Channel Crosstalk**

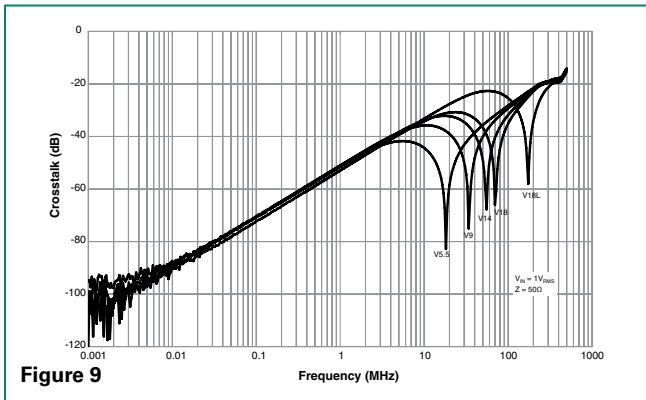

**Figure 9**

### Lead (Pb) Soldering Recommendations

The principal techniques used for the soldering of components in surface mount technology are IR Re-flow and Wave soldering. Typical profiles are shown on the right.

The recommended solder for the MLN suppressor is a 62/36/2 (Sn/Pb/Ag), 60/40 (Sn/Pb) or 63/37 (Sn/Pb). Littelfuse also recommends an RMA solder flux.

Wave soldering is the most strenuous of the processes. To avoid the possibility of generating stresses due to thermal shock, a preheat stage in the soldering process is recommended, and the peak temperature of the solder process should be rigidly controlled.

When using a reflow process, care should be taken to ensure that the MLN chip is not subjected to a thermal gradient steeper than 4 degrees per second; the ideal gradient being 2 degrees per second. During the soldering process, preheating to within 100 degrees of the solder's peak temperature is essential to minimize thermal shock.

Once the soldering process has been completed, it is still necessary to ensure that any further thermal shocks are avoided. One possible cause of thermal shock is hot printed circuit boards being removed from the solder process and subjected to cleaning solvents at room temperature. The boards must be allowed to cool gradually to less than 50°C before cleaning.

### Reflow Solder Profile

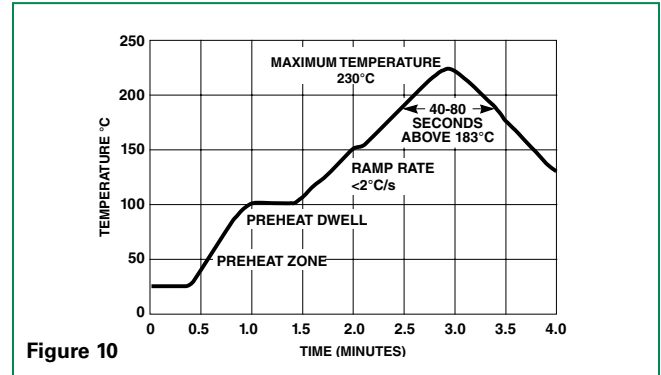

Figure 10

### Wave Solder Profile

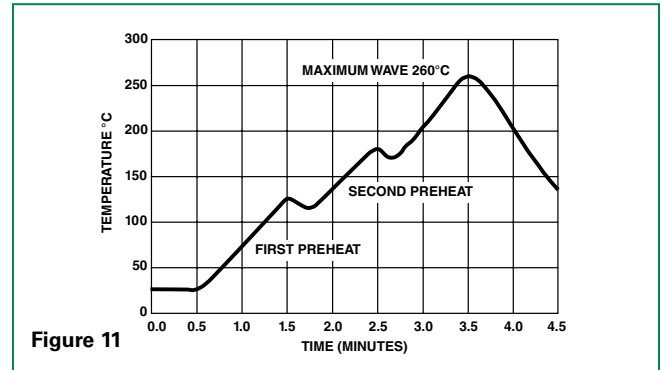
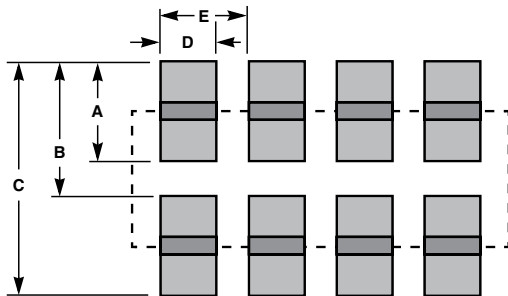

Figure 11

**Product Dimensions (mm)**

PAD LAYOUT DIMENSIONS



CHIP LAYOUT DIMENSIONS

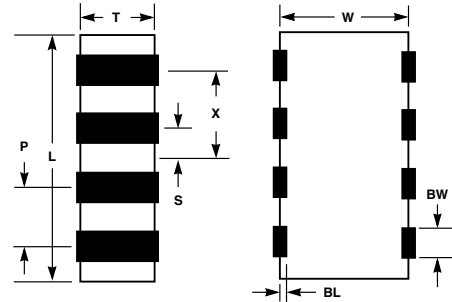

Dimension	1206 Size	
	IN	MM
<b>A</b>	0.035	0.890
<b>B</b>	0.065	1.650
<b>C</b>	0.100	2.540
<b>D</b>	0.018	0.460
<b>E</b>	0.030	0.790
<b>L</b>	3.200 +/-0.200	0.126 +/-0.008
<b>W</b>	1.600 +/-0.200	0.063 +/-0.008
<b>T</b>	1.350 Max	0.053 Max
<b>BW</b>	0.410 +/-0.100	0.016 +/-0.004
<b>BL</b>	0.180 +0.25/-0.050	0.007 +0.01/- 0.002
<b>P</b>	0.760 Ref	0.030 Ref
<b>X</b>	1.140 +/-0.100	0.045 +/-0.004
<b>S</b>	0.380 +/-0.100	0.015 +/-0.004

**Part Numbering System**

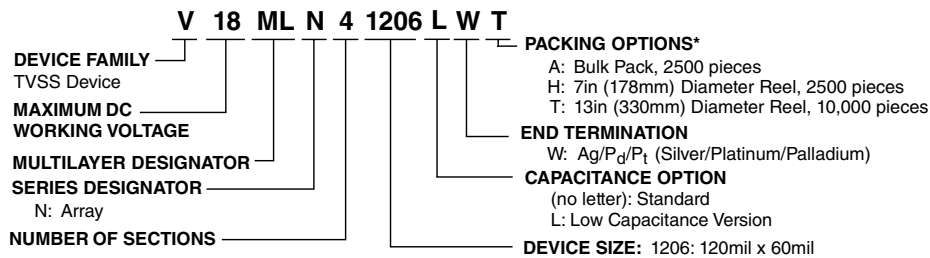

**Packaging\***

Device Size	Quantity		
	13" Inch Reel ("T" Option)	7" Inch Reel ("H" Option)	Bulk Pack ("A" Option)
1206	10,000	2,500	2,500

\*(Packaging) It is recommended that parts be kept in the sealed bag provided and that parts be used as soon as possible when removed from bags.

**Tape and Reel Specifications**

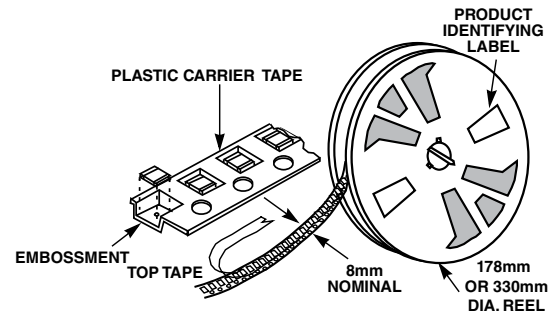
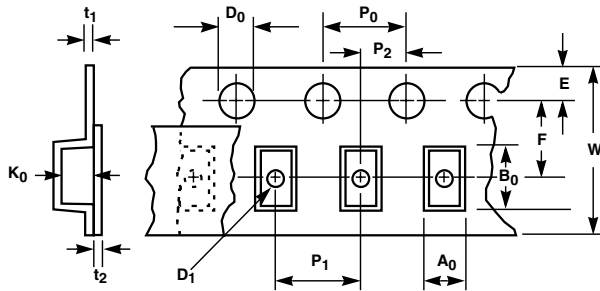

Symbol	Description	Dimensions in Millimeters
$A_0$	Width of Cavity	Dependent on Chip Size to Minimize Rotation.
$B_0$	Length of Cavity	Dependent on Chip Size to Minimize Rotation.
$K_0$	Depth of Cavity	Dependent on Chip Size to Minimize Rotation.
$W$	Width of Tape	8 -/+0.2
$F$	Distance Between Drive Hole Centers and Cavity Centers	3.5 -/+0.5
$E$	Distance Between Drive Hole Centers and Tape Edge	1.75 -/+0.1
$P_1$	Distance Between Cavity Center	4 -/+0.1
$P_2$	Axial Distance Between Drive Hole Centers and Cavity Centers	2 -/+0.1
$P_0$	Axial Distance Between Drive Hole Centers	4 -/+0.1
$D_0$	Drive Hole Diameter	1.55 -/+0.05
$D_1$	Diameter of Cavity Piercing	1.05 -/+0.05
$T_1$	Embossed Tape Thickness	0.3 Max
$T_2$	Top Tape Thickness	0.1 Max

Notes :

- Conforms to EIA-481-1, Revision A
- Can be supplied to IEC publication 286-3

**Disclaimer Notice - Information furnished is believed to be accurate and reliable. However, users should independently evaluate the suitability of and test each product selected for their own applications. Littelfuse products are not designed for, and may not be used in, all applications. Read complete Disclaimer Notice at [www.littelfuse.com/disclaimer-electronics](http://www.littelfuse.com/disclaimer-electronics).**

# Mouser Electronics

Authorized Distributor

Click to View Pricing, Inventory, Delivery & Lifecycle Information:

[Littelfuse:](#)

[V18MLN41206WT](#) [V14MLN41206WH](#) [V18MLN41206LWH](#) [V18MLN41206WH](#) [V5.5MLN41206WH](#)  
[V9MLN41206WH](#) [V5.5MLN41206WA](#) [V14MLN41206WA](#) [V18MLN41206WA](#) [V18MLN41206LWA](#) [V18MLN41206LWT](#)