

HA16617P, HA16619P ● Fluorescent Display Drivers

HA16617P and HA16619P are fluorescent display drivers operating in high voltage which use positive and negative power source, respectively.

■ FEATURES

- Capable of driving fluorescent display tube directly because of the built-in 8 circuits and the built-in pull down resistors at output.
- For the inputs, CMOS or TTL accepted.
- The output pulse is non-inverted or inverted from the input pulse in HA16617P or HA16619P, respectively.

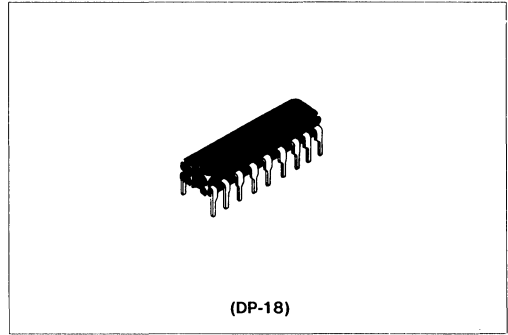

■ CIRCUIT SCHEMATIC (1/8)

● HA16617P

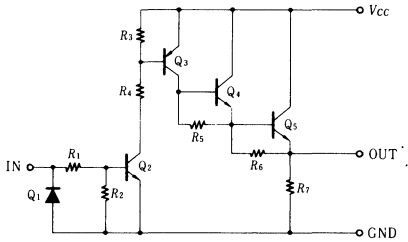

● HA16619P

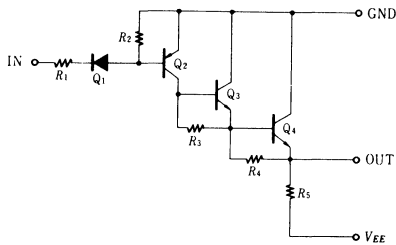

■ PIN ARRANGEMENT

● HA16617P

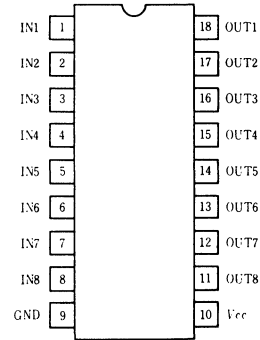

(Top View)

● HA16619P

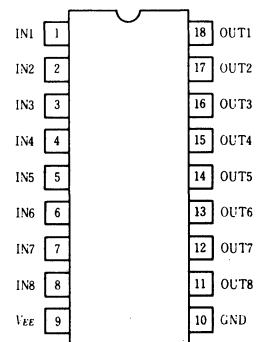

(Top View)

■ ABSOLUTE MAXIMUM RATINGS ($T_a=25^{\circ}\text{C}$)

Item	Symbol	HA16617P	HA16619P	Unit
Supply Voltage	V_{EE}	-0.3 to +65	+0.3 to -65	V
Input Voltage	V_{in}	-0.5 to +10	+0.5 to -10	V
Output Voltage	V_{out}	-0.3 to +65	+0.3 to -65	V
Output Current*	I_{out}	-45	-45	mA
Power Dissipation**	P_T	625	625	mW
Operating Temperature	T_{opr}	-20 to +75	-20 to +75	$^{\circ}\text{C}$
Storage Temperature	T_{stg}	-55 to +125	-55 to +125	$^{\circ}\text{C}$

* When only one circuit turns ON.
 ** Value when $T_a \leq 50^{\circ}\text{C}$. Derating curve above $T_a = 50^{\circ}\text{C}$ shall be $8.3\text{mW}/^{\circ}\text{C}$.

■ ELECTRICAL CHARACTERISTICS ($T_a = -20$ to $+75^{\circ}\text{C}$)

Item	Symbol	Test Conditions	HA16617P			HA16619P			Unit
			min	typ	max	min	typ	max	
Input Voltage	V_{IH}	$V_{CC}=60\text{V}, V_O \geq 57\text{V}$	2.4	—	—	—	—	—	V
		$V_{EE}=-60\text{V}, V_O \leq -55\text{V}$	—	—	—	—	—	-1.5	
	V_{IL}	$V_{CC}=60\text{V}, V_O \leq 3\text{V}$	—	—	0.4	—	—	—	V
		$V_{EE}=-60\text{V}, V_O \geq -3\text{V}$	—	—	—	-4	—	—	
Input Current	I_{IH}	$V_{CC}=60\text{V}, V_{in}=2.4\text{V}$	—	—	0.22	—	—	—	mA
		$V_{CC}=60\text{V}, V_{in}=5\text{V}$	—	—	0.45	—	—	—	
		$V_{EE}=-60\text{V}, V_{in}=-1.5\text{V}$	—	—	—	-280	—	—	
	I_{IL}	$V_{CC}=60\text{V}, V_{in}=0.4\text{V}$	—	—	80	—	—	—	μA
		$V_{EE}=-60\text{V}, V_{in}=-4\text{V}$	—	—	—	-1.2	—	—	
		$V_{EE}=-60\text{V}, V_{in}=-7\text{V}$	—	—	—	-2.6	—	—	
Output Voltage	V_{OH}	$V_{CC}=60\text{V}, V_{in}=2.4\text{V}, I_O=-40\text{mA}$	57	58.5	—	—	—	—	V
		$V_{EE}=-60\text{V}, V_{in}=-4\text{V}, I_O=-40\text{mA}$	—	—	—	-3	-1.5	—	
	V_{OL}	$V_{CC}=60\text{V}, V_{in}=0.4\text{V}$	—	—	3.0	—	—	—	V
		$V_{EE}=-60\text{V}, V_{in}=-1.5\text{V}$	—	—	—	-55	—	—	
Quiescent Current	$I_{CC(OFF)}$	$V_{CC}=60\text{V}, \text{all Circuit } V_{in}=0.4\text{V}$	—	0.04	0.4	—	—	—	mA
	$I_{EE(OFF)}$	$V_{EE}=-60\text{V}, \text{All Circuit } V_{in}=-1.5\text{V}$	—	—	—	-1.3	—	—	
	$I_{CC(ON)}$	$V_{CC}=60\text{V}, \text{One Circuit } V_{in}=2.4\text{V}$	—	—	4.0	—	—	—	mA
	$I_{EE(ON)}$	$V_{CC}=-60\text{V}, \text{All Circuit } V_{in}=-4\text{V}$	—	—	—	-12	—	—	

■ APPLICATIONS

● HA16617P

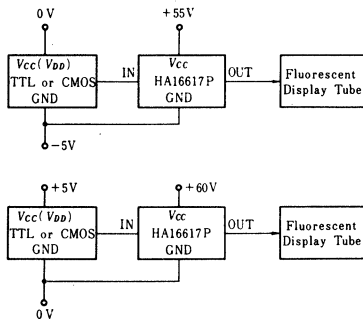

● HA16619P

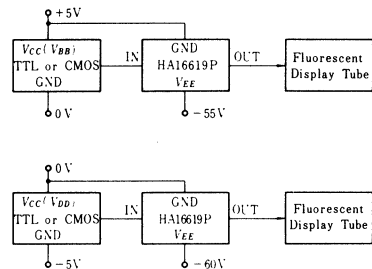

■ BASIC CIRCUIT

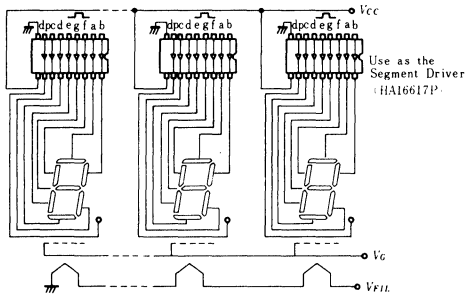

(a) Static Type

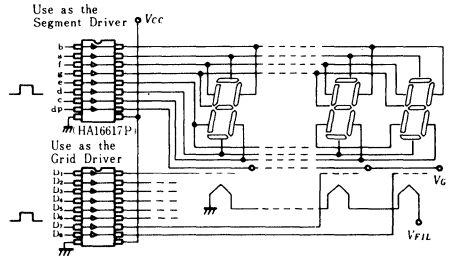

(b) Dynamic Type

HA16617PJ, HA16619PJ ● Fluorescent Display Drivers

HA16617PJ and HA16619PJ are fluorescent display drivers operating in high voltage which use positive and negative power source, respectively.

■ FEATURES

- Capable of driving fluorescent display tube directly because of the built-in 8 circuits and the built-in pull down resistors at output.
- For the inputs, CMOS or TTL accepted.
- The output pulse is non-inverted or inverted from the input pulse in 16617PJ or HA16619PJ, respectively.

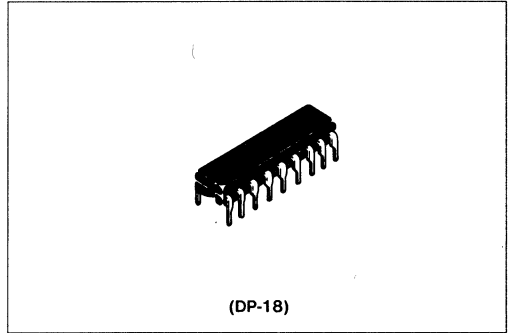

■ CIRCUIT SCHEMATIC (1/8)

● HA16617PJ

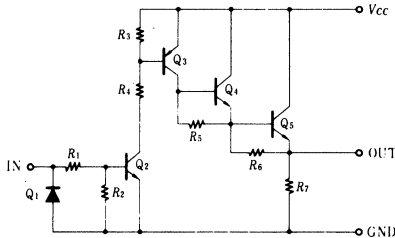

● HA16619PJ

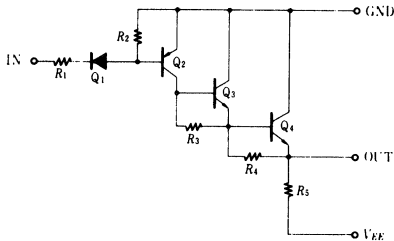

■ PIN ARRANGEMENT

● HA16617PJ

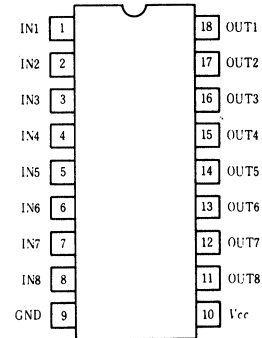

(Top View)

● HA16619PJ

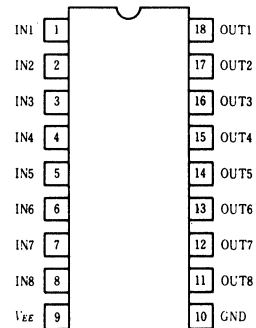

(Top View)

■ ABSOLUTE MAXIMUM RATINGS (Ta=25°C)

Item	Symbol	HA16617PJ	HA16619PJ	Unit
Supply Voltage	V_{EE}	-0.3 to +65	+0.3 to -65	V
Input Voltage	V_{in}	-0.5 to +10	+0.5 to -10	V
Output Voltage	V_{out}	-0.3 to +65	+0.3 to -65	V
Output Current *	I_{out}	-45	-45	mA
Power Dissipation **	P_T	625	625	mW
Operating Temperature	T_{opr}	-40 to +85	-45 to +85	°C
Storage Temperature	T_{stg}	-55 to +125	-55 to +125	°C

* When only one circuit turns ON

** Value when $T_a \leq 50^\circ\text{C}$. Derating curve above $T_a = 50^\circ\text{C}$ shall be 8.3mW/°C.

■ ELECTRICAL CHARACTERISTICS (Ta=-45to +85°C)

Item	Symbol	Test Conditions	HA16617PJ			HA16619PJ			Unit
			Min	Typ	Max	Min	Typ	Max	
Input Voltage	V_{IH}	$V_{CC}=60\text{V}, V_O \geq 57\text{V}$	2.5	-	-	-	-	-	V
		$V_{EE}=-60\text{V}, V_O \leq -55\text{V}$	-	-	-	-	-	-1.4	
	V_{IL}	$V_{CC}=60\text{V}, V_O \leq 3\text{V}$	-	-	0.4	-	-	-	V
		$V_{EE}=-60\text{V}, V_O \geq -3\text{V}$	-	-	-	-4.3	-	-	
Input Current	I_{IH}	$V_{CC}=60\text{V}, V_{in}=2.5\text{V}$	-	-	0.22	-	-	-	mA
		$V_{CC}=60\text{V}, V_{in}=5\text{V}$	-	-	0.45	-	-	-	
		$V_{EE}=-60\text{V}, V_{in}=-1.4\text{V}$	-	-	-280	-280	-	-	
	I_{IL}	$V_{CC}=60\text{V}, V_{in}=0.4\text{V}$	-	-	80	-	-	-	μA
		$V_{EE}=-60\text{V}, V_{in}=-4.3\text{V}$	-	-	-	-1.2	-	-	
		$V_{EE}=-60\text{V}, V_{in}=-7\text{V}$	-	-	-	-2.6	-	-	
Output Voltage	V_{OH}	$V_{CC}=60\text{V}, V_{in}=2.5\text{V}$ $I_O=-40\text{mA}$	57	58.5	-	-	-	-	V
		$V_{EE}=-60\text{V}, V_{in}=-4.3\text{V}$ $I_O=-40\text{mA}$	-	-	-	-3	-1.5	-	
	V_{OL}	$V_{CC}=60\text{V}, V_{in}=0.4\text{V}$	-	-	3.0	-	-	-	V
		$V_{EE}=-60\text{V}, V_{in}=-1.4\text{V}$	-	-	-	-55	-	-	
Quiescent Current	$I_{CC(OFF)}$	$V_{CC}=60\text{V}$, All Circuit $V_{in}=0.4\text{V}$	-	0.04	0.4	-	-	-	mA
	$I_{EE(OFF)}$	$V_{EE}=-60\text{V}$, All Circuit $V_{in}=-1.4\text{V}$	-	-	-	-1.3	-	-	
	$I_{CC(ON)}$	$V_{CC}=60\text{V}$, One Circuit $V_{in}=2.5\text{V}$	-	-	4.0	-	-	-	mA
	$I_{EE(ON)}$	$V_{CC}=-60\text{V}$, All Circuit $V_{in}=-4.3\text{V}$	-	-	-	-12	-	-	

■ APPLICATIONS

● HA16617PJ

Input voltage within 0 to +7V shall be used with regard to GND.

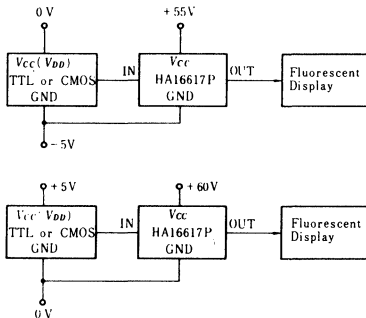

● HA16619PJ

Input voltage within 0 to -7V shall be used with regard to GND.

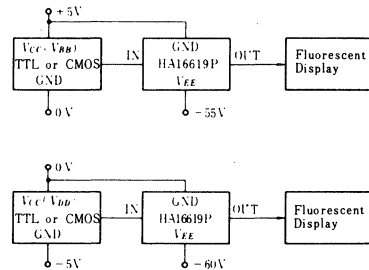

■ BASIC CIRCUIT

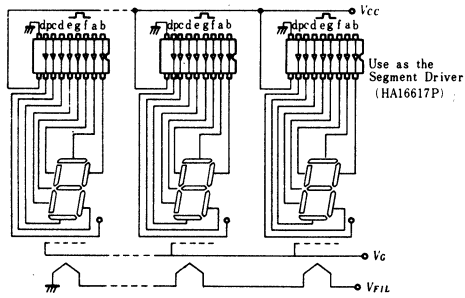

(a) Static Type

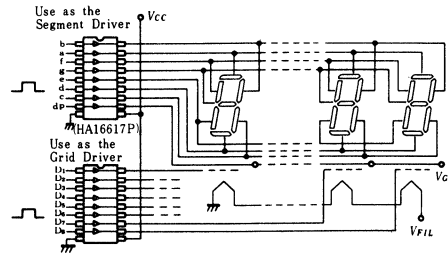

(b) Dynamic Type