

Description

- General purpose application.
- Switching application.

Features

- Excellent h_{FE} linearity.
- Complementary pair with STS9013

Ordering Information

Type NO.	Marking	Package Code
STS9012	STS9012	TO-92

Outline Dimensions

unit : mm

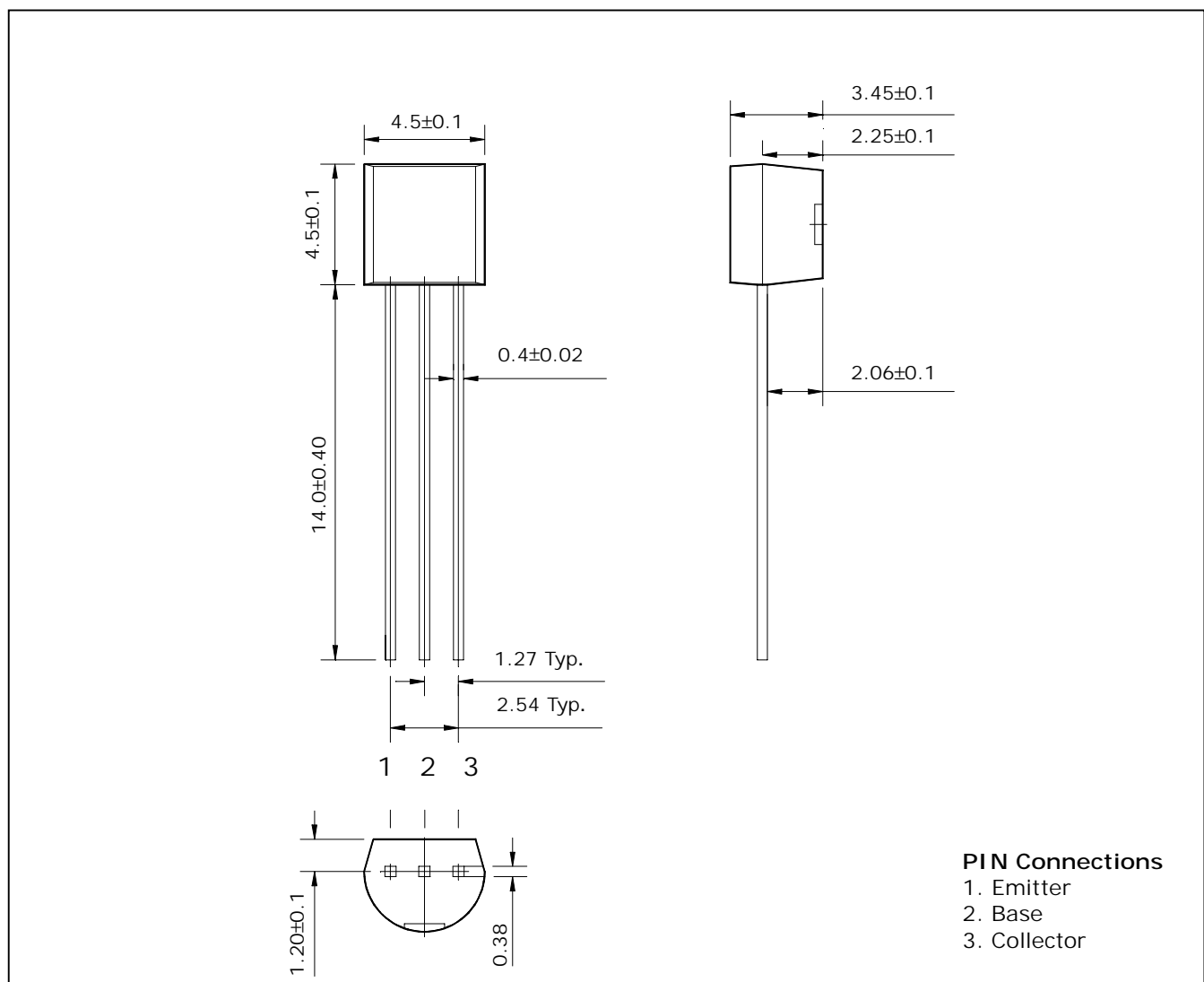

Absolute maximum ratings

(Ta=25°C)

Characteristic	Symbol	Ratings	Unit
Collector-Base voltage	V_{CBO}	-40	V
Collector-Emitter voltage	V_{CEO}	-30	V
Emitter-Base voltage	V_{EBO}	-5	V
Collector current	I_C	-500	mA
Emitter current	I_E	500	mA
Collector dissipation	P_C	625	mW
Junction temperature	T_J	150	°C
Storage temperature	T_{stg}	-55 ~ 150	°C

Electrical Characteristics

(Ta=25°C)

Characteristic	Symbol	Test Condition	Min.	Typ.	Max.	Unit
Collector cut-off current	I_{CBO}	$V_{CB} = -35V, I_E = 0$	-	-	-0.1	μA
Emitter cut-off current	I_{EBO}	$V_{EB} = -5V, I_C = 0$	-	-	-0.1	μA
DC current gain	h_{FE}^*	$V_{CE} = -1V, I_C = -50mA$	96	-	246	-
Collector-Emitter saturation voltage	$V_{CE(sat)}$	$I_C = -100mA, I_B = -10mA$	-	-0.1	-0.25	V
Base-Emitter voltage	V_{BE}	$V_{CE} = -1V, I_C = -100mA$	-	-0.8	-1.0	V
Transistor frequency	f_T	$V_{CE} = -6V, I_C = -20mA$	150	-	-	MHz
Collector output capacitance	C_{ob}	$V_{CB} = -6V, f = 1MHz$	-	7	-	pF

* : h_{FE} rank / F : 96~135, G : 118~166, H : 144~202, I : 176~246.

Electrical Characteristic Curves

Fig. 1 $P_C - T_a$

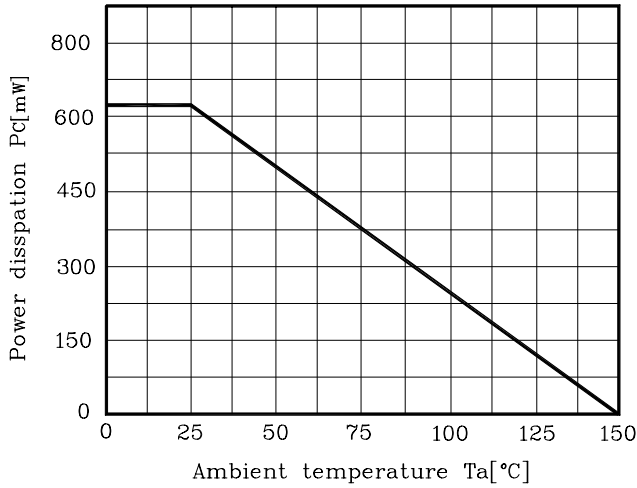

Fig. 2 $I_C - V_{BE}$

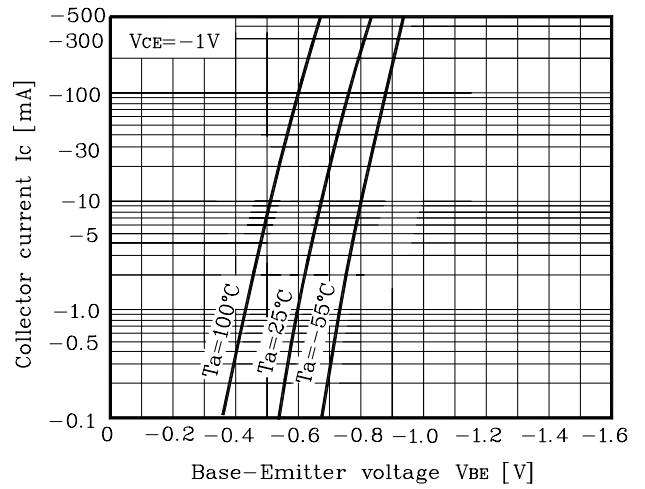

Fig. 3 $I_C - V_{CE}$

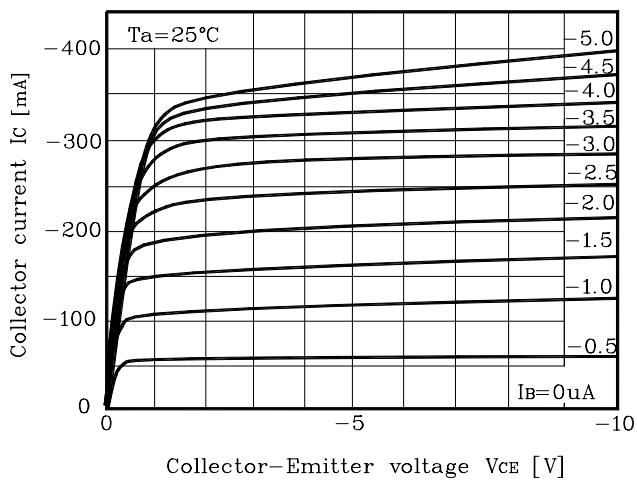

Fig. 4 $V_{CE(sat)} - I_C$

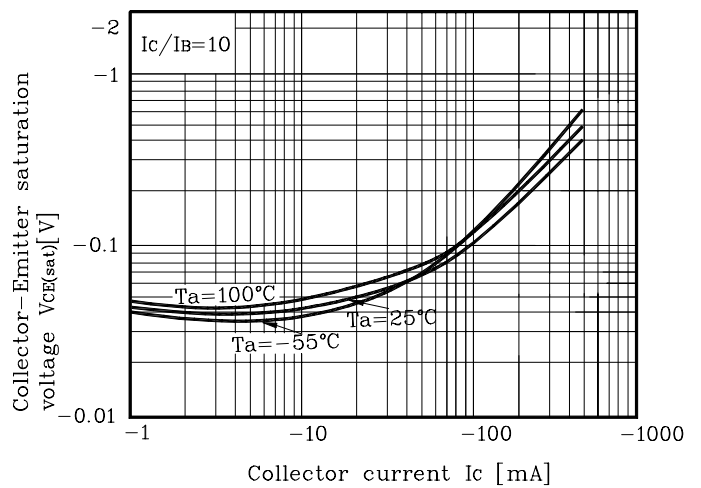

Fig. 5 $h_{FE} - I_C$

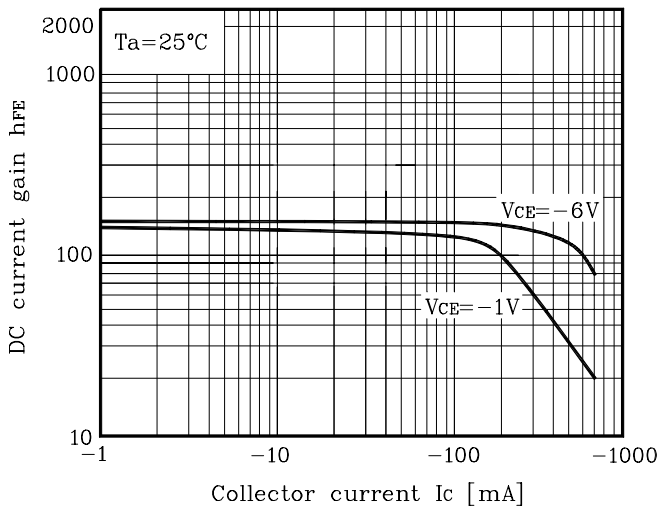
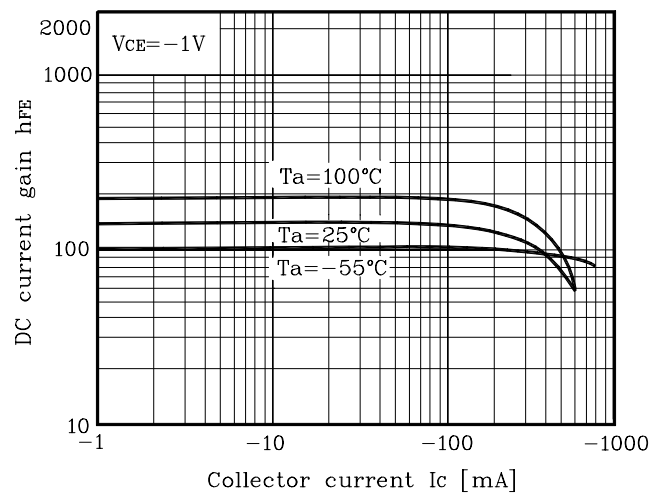

Fig. 6 $h_{FE} - I_C$



This datasheet has been download from:

www.datasheetcatalog.com

Datasheets for electronics components.