

**DESCRIPTION** The 2SB1068 is designed for use in driver and output stages of audio frequency amplifiers.

- FEATURES**
- Low Collector Saturation Voltage  
 $V_{CE(sat)} : -0.25 \text{ V TYP. } (I_C = -1.0 \text{ A, } I_B = -10 \text{ mA})$
  - High DC Current Gain  
 $h_{FE} : 350 \text{ TYP. } (V_{CE} = -2.0 \text{ V, } I_C = -100 \text{ mA})$
  - High Total Power Dissipation  $P_T : 0.75 \text{ W } (T_a = 25^\circ \text{C})$
  - Complementary to The NEC 2SD1513 NPN Transistor

**ABSOLUTE MAXIMUM RATINGS**

- Maximum Temperatures
- Storage Temperature .....  $-55 \text{ to } +150^\circ \text{C}$
  - Junction Temperature .....  $+150^\circ \text{C}$  Maximum
- Maximum Power Dissipation ( $T_a = 25^\circ \text{C}$ )
- Total Power Dissipation .....  $0.75 \text{ W}$
- Maximum Voltages and Currents ( $T_a = 25^\circ \text{C}$ )
- $V_{CBO}$  Collector to Base Voltage .....  $-20 \text{ V}$
  - $V_{CEO}$  Collector to Emitter Voltage .....  $-16 \text{ V}$
  - $V_{EBO}$  Emitter to Base Voltage .....  $-6.0 \text{ V}$
  - $I_{C(DC)}$  Collector Current .....  $-2.0 \text{ A}$
  - $I_{C(pulse)}$  \* Collector Current .....  $-3.0 \text{ A}$
- \*  $PW \leq 10 \text{ ms, Duty Cycle} \leq 50 \%$

**PACKAGE DIMENSIONS**  
in millimeters (inches)

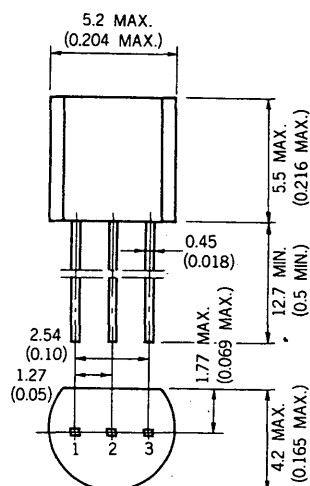

- 1. EMITTER EIAJ : SC-43B
- 2. COLLECTOR JEDEC : TO-92
- 3. BASE IEC : PA33

**ELECTRICAL CHARACTERISTICS ( $T_a = 25^\circ \text{C}$ )**

SYMBOL	CHARACTERISTIC	MIN.	TYP.	MAX.	UNIT	TEST CONDITIONS
$h_{FE1}$	DC Current Gain	135	350	650	-	$V_{CE} = -2.0 \text{ V, } I_C = -100 \text{ mA}$
$h_{FE2}$	DC Current Gain	100			-	$V_{CE} = -2.0 \text{ V, } I_C = -1.5 \text{ A}$
$f_T$	Gain Bandwidth Product	100	180		MHz	$V_{CE} = -10 \text{ V, } I_E = 50 \text{ mA}$
$C_{ob}$	Output Capacitance		60		pF	$V_{CB} = -10 \text{ V, } I_E = 0, f = 1.0 \text{ MHz}$
$I_{CBO}$	Collector Cutoff Current			-100	nA	$V_{CB} = -16 \text{ V, } I_E = 0$
$I_{EBO}$	Emitter Cutoff Current			-100	nA	$V_{EB} = -6.0 \text{ V, } I_C = 0$
$V_{BE}$	Base to Emitter Voltage	-550	-600	-650	mV	$V_{CE} = -6.0 \text{ V, } I_C = -5.0 \text{ mA}$
$V_{CE(sat)1}$	Collector Saturation Voltage		-0.25	-0.40	V	$I_C = -1.0 \text{ A, } I_B = -10 \text{ mA}$
$V_{CE(sat)2}$	Collector Saturation Voltage		-0.31	-0.50	V	$I_C = -1.5 \text{ A, } I_B = -75 \text{ mA}$
$V_{CE(sat)3}$	Collector Saturation Voltage		-0.33	-0.50	V	$I_C = -1.5 \text{ A, } I_B = -20 \text{ mA}$
$V_{BE(sat)}$	Base Saturation Voltage		-1.05	-1.2	V	$I_C = -1.5 \text{ A, } I_B = -75 \text{ mA}$

**Classification of  $h_{FE}$**

Rank	L	K	U
Range	135 - 270	200 - 400	300 - 650

Test Conditions :  $V_{CE} = -2.0 \text{ V, } I_C = -100 \text{ mA}$

TYPICAL CHARACTERISTICS ( $T_a = 25^\circ\text{C}$ )

TOTAL POWER DISSIPATION vs. AMBIENT TEMPERATURE

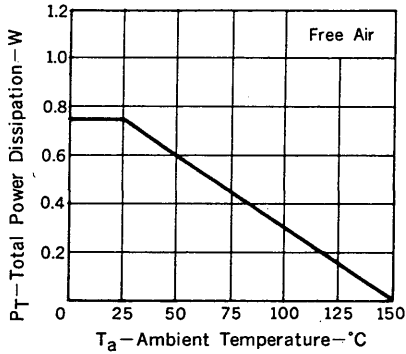

SAFE OPERATING AREAS (TRANSIENT THERMAL RESISTANCE METHOD)

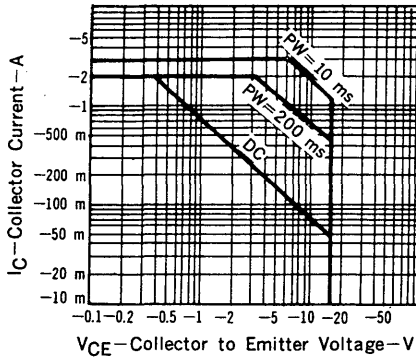

COLLECTOR CURRENT vs. COLLECTOR TO EMITTER VOLTAGE

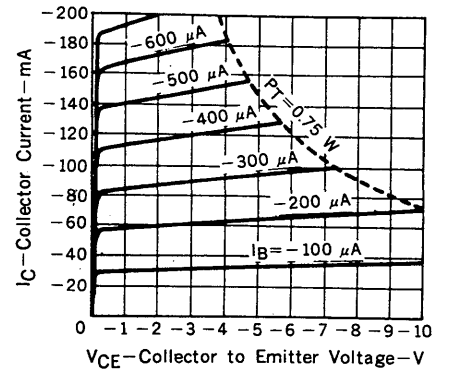

COLLECTOR CURRENT vs. COLLECTOR TO EMITTER VOLTAGE

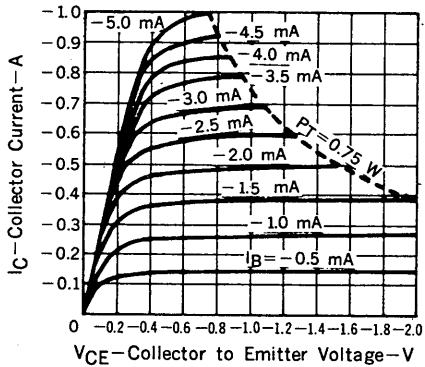

DC CURRENT GAIN vs. COLLECTOR CURRENT

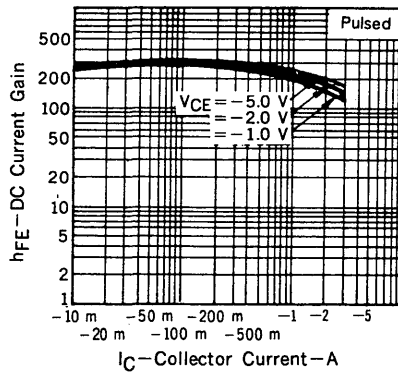

COLLECTOR CURRENT vs. BASE TO EMITTER VOLTAGE

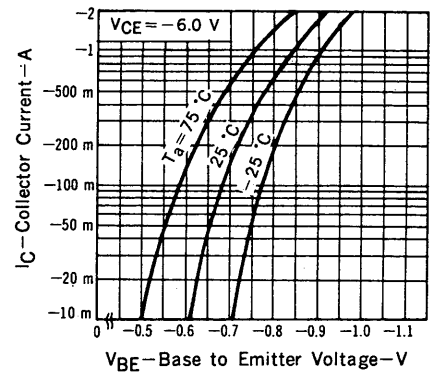

BASE AND COLLECTOR SATURATION VOLTAGE vs. COLLECTOR CURRENT

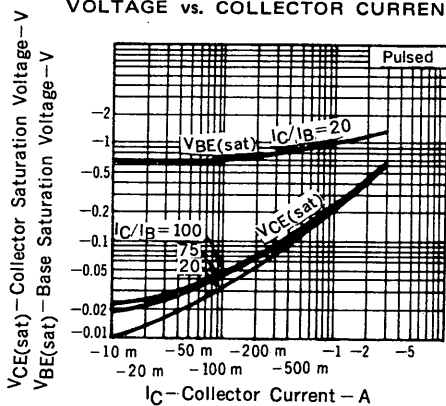

GAIN BANDWIDTH PRODUCT vs. EMITTER CURRENT

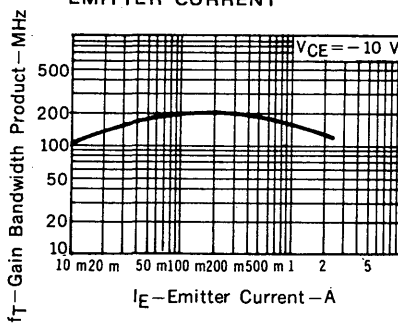

OUTPUT CAPACITANCE vs. COLLECTOR TO BASE VOLTAGE

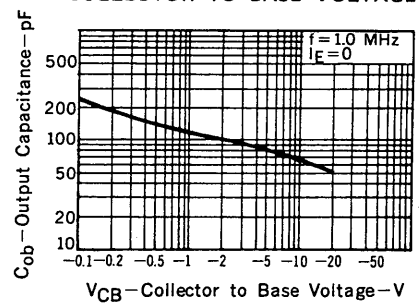

This datasheet has been downloaded from:

[www.DatasheetCatalog.com](http://www.DatasheetCatalog.com)

Datasheets for electronic components.